

Call to order 717-209-7100

<http://controlparts.com/eaton/eaton-pkzm0.htm>

Motor protective circuit breakers PKZ



1.1	xStart series motor-protective circuit-breakers	1
	Motor-protective circuit-breakers PKZ	3
	Motor-protective circuit-breakers PKE	8
1.2	xStart C series motor-protective circuit-breakers	
	Motor-protective circuit-breakers PKZMC	47

Motor protective circuit breaker PKE



Motor protective circuit breaker PKZMC





PKZ and PKE motor-protective circuit-breakers

Machinery and installation downtimes should be kept as short as possible. The PKZ fuseless motor-protective circuit-breakers combine short-circuit and overload protection in one device, allowing fast restart readiness. PKZM01, PKZM0, PKZM4 and PKE have the same accessories. Combines easily with DILM (C) contactors and DS7 soft starters. Connecting PKE to SmartWire-DT[®] facilitates high data transparency.

ATEX 

PKZM01 (up to 25 A) motor-protective circuit-breaker with pushbuttons

- Motor-protective circuit-breaker in housing for protection types IP40 and IP65.
- Integrated EMERGENCY STOP and EMERGENCY OFF pushbuttons reduce wiring.

PKZM0 (up to 32 A) and PKZM4 (up to 65 A) motor-protective circuit-breakers with rotary handle

- Short-circuit proof up to at least 50 kA for easy engineering.
- Trip-indicating auxiliary contact enables remote diagnosis.
- High safety through application as main switch or repair and maintenance switch.
- ATEX approval for protection of EEx e motors up to 65 A.

PKE (up to 65 A) motor-protective circuit-breakers with electronic wide-range overload protection

- High flexibility through plug-in trip block.
- Wide current setting ranges enable only five trip blocks up to 65 A.
- Precise and extremely long-term stable characteristic curves.
- Individual supply through integrated current converter.
- ATEX approval for protection of EEx e motors up to 65 A.
- Adjustable tripping classes.



Motor-protective circuit-breaker PKZM01, PKZM0, PKZM4, PKE



Contents

Description

Page

System overview	
PKZM01, PKZM0, PKZM4, PKE motor-protective circuit-breakers	2
Ordering	
Motor-protective circuit-breakers	3
Transformer-protective circuit-breakers	6
PKE electronic motor-protective circuit-breaker	8
Standard auxiliary contacts	10
Auxiliary contacts, shunt releases, undervoltage release	12
Engineering	
Accessories for motor-protective circuit-breakers in enclosures	14
Ordering	
Insulated enclosures	16
Accessories	20
Busbar adapters	22
Wiring sets	25
Motor feeder plugs, three-phase commoning links	26
Actuating voltages	29
Engineering	
Motor-protective circuit-breakers	30
Characteristic curves	30
Switching capacity	32
Technical data	
Motor-protective circuit-breakers	36
Auxiliary contacts	38
Dimensions	
PKZM01, PKZM0 motor-protective circuit-breaker	39
Accessories	40

1.1

Motor-protective circuit-breakers PKZM01, PKZM0, PKZM4, PKE

Motor-protective circuit-breaker

1 System overview

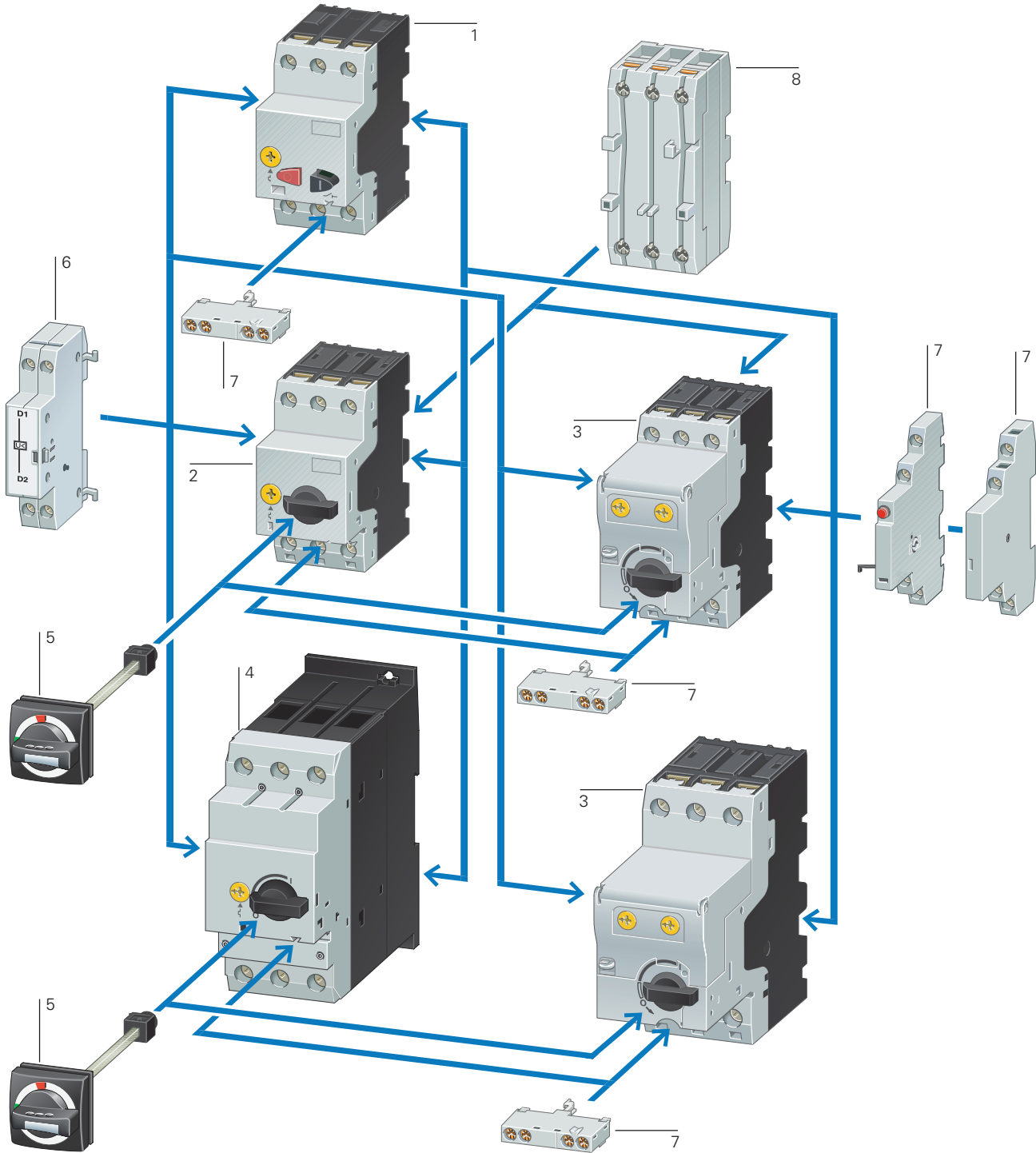

Basic devices

Motor-protective circuit-breaker PKZM01	1
→ Page 3	
Motor-protective circuit-breaker PKZM0	2
→ Page 4	

Motor-protective circuit-breaker with wide-range overload protection	3
→ Page 8	
Motor-protective circuit-breaker PKZM4	4
→ Page 4	

Add-on functions

Standard auxiliary contacts	7
→ Page 10	
Shunt release	6
→ Page 29	
Current limiters	8
→ Page 12	

Mounting accessories

Door coupling handles IP65	5
→ Page 20	
Insulated enclosure	
→ Page 16	
Mounting/wiring	
→ Page 22	

Ordering

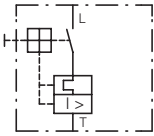
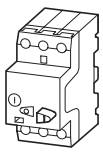

PKZM01

Max. motor rating AC-3		
220 V	380 V	440 V
230 V	400 V	
240 V	415 V	

Rated uninterupted current

Setting range

Overload releases Short-circuit releases

P	P	P	I_u	I_r	I_{rm}
kW	kW	kW	A	A	A

Screw terminals

Part no. Article no. Price See price list

Std. pack

Information relevant for export to North America



Motor-protective circuit-breakers, type "1"; and type "2" coordination

–	–	–	0.16	0.1...0.16	2.2	PKZM01-0.16 278475	1 off	Product Standards	UL 508; CSA-C22.2 No.14; IEC60947-4-1; CE marking				
–	0.06	0.06	0.25	0.16...0.25	3.5	PKZM01-0.25 278476	1 off	UL File No.	E36332				
0.06	0.09	0.12	0.4	0.25...0.4	5.6	PKZM01-0.4 278477	1 off	UL CCN	NLRV				
0.09	0.12	0.18	0.63	0.4...0.63	8.8	PKZM01-0.63 278478	1 off	CSA File No.	12528				
0.12	0.25	0.25	1	0.63...1	14	PKZM01-1 278479	1 off	CSA Class No.	3211-05				
0.25	0.55	0.55	1.6	1...1.6	22	PKZM01-1.6 278480	1 off	NA Certification	UL Listed, CSA certified				
0.37	0.75	1.1	2.5	1.6...2.5	35	PKZM01-2.5 278481	1 off	Suitable for	Branch circuits, or suitable for group installations				
0.75	1.5	1.5	4	2.5...4	56	PKZM01-4 278482	1 off	See also	→ Page 34				
1.1	2.2	3	6.3	4...6.3	88	PKZM01-6.3 278483	1 off						
2.2	4	4	10	6.3...10	140	PKZM01-10 278484	1 off						
3	5.5	5.5	12	8...12	168	PKZM01-12 278485	1 off						
4	7.5	9	16	10...16	224	PKZM01-16 283390	1 off						
5.5	9	11	20	16...20	280	PKZM01-20 283383	1 off	Product Standards	UL 508; CSA-C22.2 No.14; IEC/EN 60947-4-1; CE marking				
5.5	12.5	12.5	25	20...25	350	PKZM01-25 288893	1 off	UL File No.	E36332				
								UL CCN	NLRV				
								CSA File No.	12528				
								CSA Class No.	3211-05				
								NA Certification	UL Listed, CSA certified				

Notes

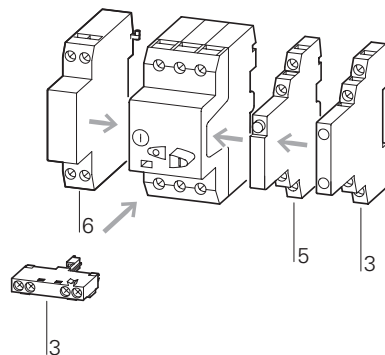

Accessories

- 3 Standard auxiliary contacts
- 5 Trip-indicating auxiliary contact
- 6 Shunt release, undervoltage release

Page

- 10
- 12
- 29

Phase failure sensitivity to IEC/EN 60947-4-1, VDE 0660 Part 102.

Can be snap-fitted to IEC/EN 60715 top-hat rail with 7.5 or 15 mm height

Circuit diagrams

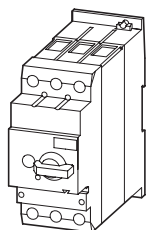
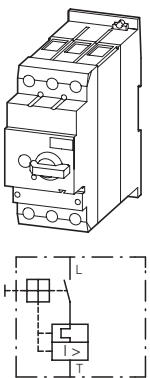
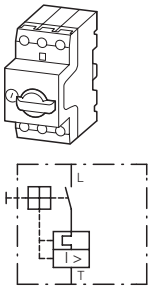

PKZM0, PKZM4

Max. motor rating AC-3						Rated uninter-rupted current	Setting range		Part no. Article no.	Price See price list	Screw terminals	
220 V	380 V	440 V	500 V	660 V	690 V		Overload releases	Short-circuit releases			Part no. Article no.	Price See price list
P kW	P kW	P kW	P kW	P kW	I_u A	I_r A	I_{sc} A					
230 V	400 V											
240 V	415 V											
Motor-protective circuit-breakers, type "1" and type "2" coordination												
-	-	-	-	0.06	0.16	0.1	0.16	2.2	PKZM0-0.16 072730		PKZM0-0.16-SC 229828	
-	0.06	0.06	0.06	0.12	0.25	0.16	0.25	3.5	PKZM0-0.25 072731		PKZM0-0.25-SC 229829	
0.06	0.09	0.12	0.12	0.18	0.4	0.25	0.4	5.6	PKZM0-0.4 072732		PKZM0-0.4-SC 229830	
0.09	0.12	0.18	0.25	0.25	0.63	0.4	0.63	8.8	PKZM0-0.63 072733		PKZM0-0.63-SC 229831	
0.12	0.25	0.25	0.37	0.55	1	0.63	1	14	PKZM0-1 072734		PKZM0-1-SC 229832	
0.25	0.55	0.55	0.75	1.1	1.6	1	1.6	22	PKZM0-1.6 072735		PKZM0-1.6-SC 229833	
0.37	0.75	1.1	1.1	1.5	2.5	1.6	2.5	35	PKZM0-2.5 072736		PKZM0-2.5-SC 229834	
0.75	1.5	1.5	2.2	3	4	2.5	4	56	PKZM0-4 072737		PKZM0-4-SC 229835	
1.1	2.2	3	3	4	6.3	4	6.3	88	PKZM0-6.3 072738		PKZM0-6.3-SC 229836	
2.2	4	4	4	7.5	10	6.3	10	140	PKZM0-10 072739		PKZM0-10-SC 229837	
3	5.5	5.5	5.5	11	12	8	12	168	PKZM0-12 278486		PKZM0-12-SC 278487	
4	7.5	9	9	12.5	16	10	16	224	PKZM0-16 046938		PKZM0-16-SC 229838	
5.5	9	11	12.5	15	20	16	20	280	PKZM0-20 046988			
5.5	12.5	12.5	15	22	25	20	25	350	PKZM0-25 046989			
7.5	15	15	22	30	32	25	32	448	PKZM0-32 278489			
Motor-protective circuit-breakers, type "1" and type "2" coordination												
4	7.5	9	9	12.5	16	10	16	224	PKZM4-16 222350			
5.5	12.5	12.5	15	22	25	16	25	350	PKZM4-25 222352			
7.5	15	17.5	22	22	32	25	32	448	PKZM4-32 222353			
11	20	22	24	30	40	32	40	560	PKZM4-40 222354			
14	25	30	30	45	50	40	50	700	PKZM4-50 222355			
17	30	37	37	55	58	50	58	812	PKZM4-58 222394			
18.5	34	37	45	55	65	55	65	882	PKZM4-63 222413			
Circuit-breakers For line and cable protection												
-	-	-	-	-	16	10	16	224	PKZM4-16-CB 132591			
-	-	-	-	-	25	16	25	350	PKZM4-25-CB 132592			
-	-	-	-	-	32	25	32	448	PKZM4-32-CB 132593			

Spring-loaded terminals

Part no.
Article no.

Price
See price list

Std. pack

Notes

Information relevant for export to North America



PKZM0-0,16-C
229669

1 off

PKZM0-0,25-C
229670

PKZM0-0,4-C
229671

PKZM0-0,63-C
229672

PKZM0-1-C
229673

PKZM0-1,6-C
229674

PKZM0-2,5-C
229675

PKZM0-4-C
229676

PKZM0-6,3-C
229677

PKZM0-10-C
229678

PKZM0-12-C
278488

PKZM0-16-C
229679

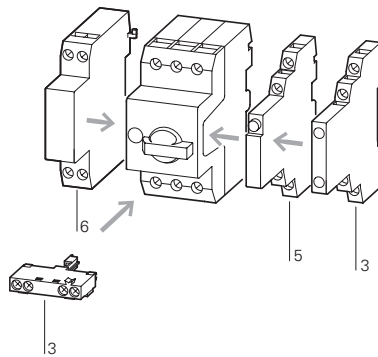

Accessories

- 3 Standard auxiliary contacts
- 5 Trip-indicating auxiliary contact
- 6 Shunt release, undervoltage release

Page

- 10
- 12
- 29

Phase failure sensitivity to IEC/EN 60947-4-1, VDE 0660 Part 102.
Can be snap-fit to IEC/EN 60715 top-hat rail with 7.5 or 15 mm height

PTB 02 ATEX 3151, see manual

→ 21

Product Standards UL 508; CSA-C22.2 No.14; IEC60947-4-1; CE marking

UL File No. E36332

UL CCN NLRV

CSA File No. 12528

CSA Class No. 3211-05

NA Certification UL Listed, CSA certified

Suitable for Branch circuit: Manual type E if used with terminal, or suitable for group installations

See also → Page 34

1 off

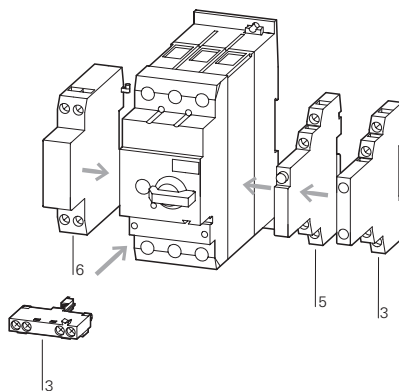

Accessories

- 3 Standard auxiliary contacts → 10
- 5 Trip-indicating auxiliary contact → 12
- 6 Shunt release, undervoltage release → 29

Only motor-protective circuit-breaker:

Phase failure sensitivity to IEC/EN 60947-4-1, VDE 0660 Part 102

Can be snap-fitted to IEC/EN 60715 top-hat rail with 7.5 or 15 mm height

PTB 02 ATEX 3153, see manual

→ 21

1 off

Not usable as a main switch

Phase failure sensitivity to IEC/EN 60947-4-1, VDE 0660 Part 102.

Switching capacity of SCCR
65 kA (480 Y/277 V)
22 kA (600 Y/347 V)

Product Standards UL 489; CSA-C22.2 No.5-09; IEC 60947-4-1; CE marking

NA Certification Request filed for UL and CSA

Specially designed for NA Yes
Suitable for Feeder and branch circuit as BCPD

1.1

Motor-protective circuit-breakers PKZM01, PKZM0, PKZM4, PKE

Transformer-protective circuit-breakers

1

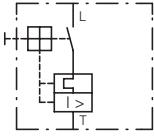
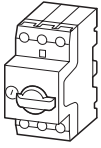

PKZM0

Max. motor rating
AC-3

Rated
uninterrupted
current

Setting range

Overload
releases

Short-circuit
releases

Screw terminals

Part no.
Article no.

Price
See price
list

Std.
pack

220 V	380 V	440 V	500 V	660 V
230 V	400 V			690 V
240 V	415 V			

P	P	P	P	P	I_u	I_r	I_{rm}
kW	kW	kW	kW	kW	A	A	A

–	–	–	–	–	0.16	0.1...0.16	2.4	PKZM0-0,16-T 088907		1 off
–	–	–	–	–	0.25	0.16...0.25	4.25	PKZM0-0,25-T 088908		1 off
–	–	–	–	–	0.4	0.25...0.4	6.8	PKZM0-0,4-T 088909		1 off
–	–	–	–	–	0.63	0.4...0.63	12	PKZM0-0,63-T 088910		1 off
–	–	–	–	–	1	0.63...1	20	PKZM0-1-T 088911		1 off
–	–	–	–	–	1.6	1...1.6	32	PKZM0-1,6-T 088912		1 off
–	–	–	–	–	2.5	1.6...2.5	50	PKZM0-2,5-T 088913		1 off
–	–	–	–	–	4	2.5...4	84	PKZM0-4-T 088914		1 off
–	–	–	–	–	6.3	4...6.3	141	PKZM0-6,3-T 088915		1 off
–	–	–	–	–	10	6.3...10	224	PKZM0-10-T 088916		1 off
–	–	–	–	–	12	8...12	224	PKZM0-12-T 278492		1 off
–	–	–	–	–	16	10...16	280	PKZM0-16-T 088917		1 off
–	–	–	–	–	20	16...20	350	PKZM0-20-T 088918		1 off
–	–	–	–	–	25	20...25	437	PKZM0-25-T 278493		1 off

Notes

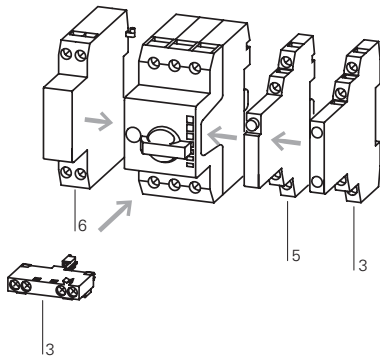

Accessories

- 3 Standard auxiliary contacts
- 5 Trip-indicating auxiliary contact
- 6 Shunt release, undervoltage release

Page

- 10
- 12
- 29

For the protection of transformers with a high inrush current
Can be snap-fitted to IEC/EN 60715 top-hat rail with 7.5 or 15 mm height
Phase failure sensitivity to IEC/EN 60947-4-1, VDE 0660 Part 102.

1.1

Motor-protective circuit-breakers PKZM01, PKZM0, PKZM4, PKE













Motor-protective circuit-breaker PKE

1

Motor rating

Motor full-load current

Basic device

P kW	AC-3					Setting range Overload releases	Part no. Article no.	See price list	Std. pack
	220 V	380 V	440 V	500 V	660 V 690 V				
	I A	I A	I A	I A	I A				
Motor-protective circuit-breakers, type "1" and type "2" coordination									
0.06	0.37	—	—	—	—	0.3...1.2 A	PKE12 121721		1off  
0.09	0.54	0.31	—	—	—				
0.12	0.72	0.41	0.37	0.33	—				
0.18	1.04	0.6	0.54	0.48	0.35				
0.25	—	0.8	0.76	0.7	0.5				
0.37	—	1.1	1.02	0.9	0.7				
0.55	—	—	—	—	0.9				
0.75	—	—	—	—	1.1				
0.18	1.04	—	—	—	—	1...4 A	PKE12 121721		1off  
0.25	1.4	—	—	—	—				
0.37	2	1.1	1.02	—	—				
0.55	2.7	1.5	1.39	1.2	—				
0.75	3.2	1.9	1.68	1.5	1.1				
1.1	—	2.6	2.41	2.1	1.5				
1.5	—	3.6	3.28	2.9	2.1				
2.2	—	—	—	4	2.9				
3	—	—	—	—	3.8				
0.75	3.2	—	—	—	—	3...12 A	PKE12 121721		1off  
1.1	4.6	—	—	—	—				
1.5	6.3	3.6	3.3	—	—				
2.2	8.7	5	4.6	4	—				
3	11.5	6.6	6	5.3	3.8				
4	—	8.5	7.7	6.8	4.9				
5.5	—	11.3	10.2	9	6.5				
7.5	—	—	—	—	8.8				
2.2	8.7	—	—	—	—	8...32 A	PKE32 121722		1off  
3	11.5	—	—	—	—				
4	14.8	8.5	—	—	—				
5.5	19.6	11.3	10.2	9	—				
7.5	26.4	15.2	13.8	12.1	8.8				
11	—	21.7	19.8	17.4	12.6				
15	—	29.3	26.6	23.4	17				
18.5	—	—	—	28.9	20.9				
22	—	—	—	—	23.8				
30	—	—	—	—	32				
5.5	19.6	—	—	—	—	16...65 A	PKE65 138258		1off  
7.5	26.4	—	—	—	—				
11	38	21.7	19.7	17.4	—				
15	51	29.3	26.6	23.4	17				
18.5	63	36	32.9	28.9	20.9				
22	—	41	37.4	33	23.8				
30	—	55	50.3	44	32				
37	—	—	61.4	54	39				
45	—	—	—	65	47				
55	—	—	—	—	58				
2.2	8.7	—	—	—	—	8...32 A	PKE65 138258		1off  
3	11.5	—	—	—	—				
4	14.8	8.5	—	—	—				
5.5	19.6	11.3	10.2	9	—				
7.5	26.4	15.2	13.8	12.1	8.8				
11	—	21.7	19.8	17.4	12.6				
15	—	29.3	26.6	23.4	17				
18.5	—	—	—	28.9	20.9				
22	—	—	—	—	23.8				
30	—	—	—	—	32				

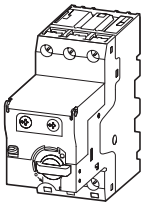
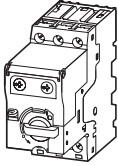

Motor-protective circuit-breakers PKZM01, PKZM0, PKZM4, PKE

Motor-protective circuit-breaker PKE

1.1

1

Trip module Standard				Trip module Expanded			Motor-protective circuit-breakers Standard Complete device			
usable for	Part no. Article no.	See price list	Std. pack	usable for	Part no. Article no.	See price list	Std. pack	Part no. Article no.	See price list	Std. pack
PKE12	PKE-XTU-1,2 121723		1off  	PKE12	PKE-XTUA-1,2 121727		1off  	PKE12/XTU-1,2 121731		1off  
PKE12	PKE-XTU-4 121724		1off  	PKE12	PKE-XTUA-4 121728		1off  	PKE12/XTU-4 121732		1off  
PKE12 PKE32	PKE-XTU-12 121725		1off  	PKE12 PKE32	PKE-XTUA-12 121729		1off  	PKE12/XTU-12 121733		1off  
PKE32	PKE-XTU-32 121726		1off  	PKE32	PKE-XTUA-32 121730		1off  	PKE32/XTU-32 121734		1off  
PKE65	PKE-XTU-65 138259		1off  	PKE65	PKE-XTUA-65 138260		1off  	PKE65/XTU-65 138516		1off
PKE65	PKE-XTUW-32 138261		1off  	PKE65	PKE-XTUWA-32 138262		1off  	PKE65/XTUW-32 138517		1 off

Information relevant for export to North America



Product Standards
NA Certification

UL 508; CSA-C22.2 No. 14; IEC60947-4-1; CE marking
Request filed for UL and CSA

1.1

Motor-protective circuit-breakers PKZM01, PKZM0, PKZM4, PKE

Standard auxiliary contacts

1

NHI...-PKZ0... Standard auxiliary contacts

For motor-protective circuit-breakers

Contact configuration	Contact sequence	Circuit diagrams	Connection method	For use with	Part no. Article no.	Price See price list	Std. pack
1 N/O N/O=normally open contact	1 NC NC=normally closed contact			Screw terminals	PKZM01 PKZM0 PKZM4 PKZM0-T PKM0 PKE	NHI11-PKZ0 072896	5 off
1 N/O	1 NC			Spring-loaded terminals	PKZM01 PKZM0 PKZM4 PKZM0-T PKM0 PKE	NHI11-PKZ0-C 229680	5 off
1 N/O	2 NC			Screw terminals	PKZM01 PKZM0 PKZM4 PKZM0-T PKM0 PKE	NHI12-PKZ0 072895	5 off
2 N/O	1 NC			Screw terminals	PKZM01 PKZM0 PKZM4 PKZM0-T PKM0 PKE	NHI21-PKZ0 072894	5 off
1 N/O	1 NC			Screw terminals	PKZM01 PKZM0 PKZM4 PKZM0-T PKM0 PKE	NHI-E-11-PKZ0 082882	5 off
1 N/O	-			Screw terminals	PKZM01 PKZM0 PKZM4 PKZM0-T PKM0 PKE	NHI-E-10-PKZ0 082884	5 off
1 N/O	-			Spring-loaded terminals	PKZM01 PKZM0 PKZM4 PKZM0-T PKM0 PKE	NHI-E-10-PKZ0-C 229681	5 off
-	1 NC			Spring-loaded terminals	PKZM01 PKZM0 PKZM4 PKZM0-T PKM0 PKE	NHI-E-01-PKZ0-C 229682	5 off
1 N/O	1 NC			Screw terminals	PKZM01 PKZM0 PKZM4 PKZM0-T PKM0 PKE	NHI-B-11-PKZ0 208277	5 off

Notes

Can be fitted to the right side of: motor-protective circuit-breakers, transformer protective circuit breakers and motor-protective circuit-breakers for starter combinations

Can be combined with:
Trip-indicating auxiliary contact AGM, NHI-E...

Notes

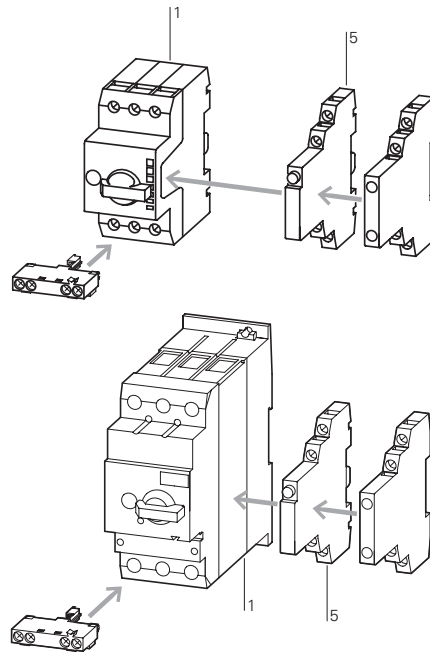

Information relevant for export to North America



Product Standards	UL 508; CSA-C22.2No.14; IEC 60947-4-1; CE marking
UL File No.	E36332
UL CCN	NLRV
CSA File No.	12528
CSA Class No.	3211-05
NA Certification	UL Listed, CSA certified

Can be fitted to motor-protective circuit-breakers, transformer-protective circuit-breakers and motor-protective circuit-breakers for starter combinations from serial number 01. 45 mm (PKZM0 and PKZM01) or 55 mm (PKZM4) widths of the motor-protective circuit-breakers remain unchanged.
NHI-E...-PKZ0-C not for use with MSC...-type motor starter combinations.

Accessories

- 1 Motor-protective circuit-breakers → 4
- 5 Trip-indicating auxiliary contact → 12
- Additional accessories → 20

AGM2...., VHI...

Contact configuration

N/O = normally open contact
NC = normally closed contact

Contact sequence

Circuit diagrams

For use with

Part no.
Article no.

Price
See price list

Std. pack

Trip indicators

For motor-protective circuit-breakers

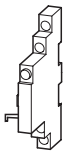

2 x 1 N/O	—	<p>Einschalten/Ausschalten</p> <p>L1L2L3 "4" "1">"</p> <p>Auslösen "4"</p> <p>L1L2L3 "4" "1">"</p>	<p>"4" "1">" 4.43 4.13</p> <p>4.44 4.14</p>	PKZM0 PKZM4 PKZM0-T PKM0 PKZM01 PKE	AGM2-10-PKZ0 072898	2 off
—	2 x 1 NC	<p>Einschalten/Ausschalten</p> <p>L1L2L3 "4" "1">"</p> <p>Auslösen "4"</p> <p>L1L2L3 "4" "1">"</p>	<p>"4" "1">" 4.31 4.21</p> <p>4.32 4.22</p>	PKZM0 PKZM4 PKZM0-T PKM0 PKZM01 PKE	AGM2-01-PKZ0 072899	2 off

Early-make auxiliary contacts

For motor-protective circuit-breakers



2 N/O	—	—	<p>3.13 3.23</p>	PKZM0 PKZM0-T PKM0 PKZM4	VHI20-PKZ0 203595	2 off
2 N/O	—	—	<p>3.14 3.24</p>	PKZM01	VHI20-PKZ01 278495	5 off

Shunt release (for power circuit-breakers)

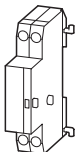

—	—	—	<p>C1</p>	PKZM0 PKZM4 PKZM0-T PKM0 PKZM01 PKE	A-PKZ0(230V50Hz) 073187	2 off
—	—	—	<p>C2</p>	PKZM0 PKZM4 PKZM0-T PKM0 PKZM01 PKE	A-PKZ0(24VDC) 073200	2 off

Undervoltage release

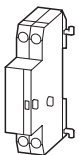

—	—	—	<p>D1</p> <p>U<</p> <p>D2</p>	PKZM0 PKZM4 PKZM0-T PKM0 PKZM01 PKE	U-PKZ0(230V50Hz) 073135	2 off
---	---	---	----------------------------------	--	-----------------------------------	-----------

Current limiters

For increasing switching capacity of motor-protective circuit-breakers without auto-protection

—	—	—	<p>"1">></p> <p>T</p>	PKZM0 PKZM4 PKE	CL-PKZ0 082881	1 off
---	---	---	-----------------------------	-----------------------	--------------------------	-----------

Notes

Can be fitted to the right side of motor-protective circuit-breakers

Can be combined with:
Standard auxiliary contacts
NHI11-PKZO
NHI12-PKZO
NHI21-PKZO
NHI-E...

Separate indication of:
a) General trip indication (overload)
b) Short-circuit trip

Local short-circuit indication by red indicator, manually resettable.

Can be fitted to front of motor-protective circuit-breaker, 45 mm width of the motor-protective circuit-breaker remains unchanged.
For early energization of undervoltage release, e.g. in emergency switching off circuits to EN 60204.
VHI20-PKZO cannot be used in combination with PKZO-X(R).

Notes

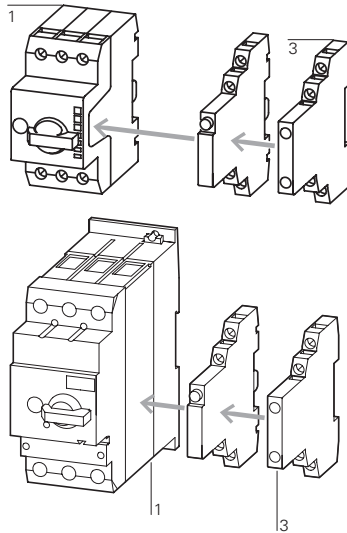

Accessories

- 1 Motor-protective circuit-breakers
- 3 Standard auxiliary contacts

Page

- 4
- 10

Information relevant for export to North America



Product Standards	UL 508; CSA-C22.2No.14; IEC60947-4-1; CE marking
UL File No.	E36332
UL CCN	NLRV
CSA File No.	12528
CSA Class No.	3211-05
NA Certification	UL Listed, CSA certified

Can be fitted to the left side of motor-protective circuit-breakers.
Cannot be combined with:
undervoltage release U-PKZO
DC: Intermittent operation 5 s

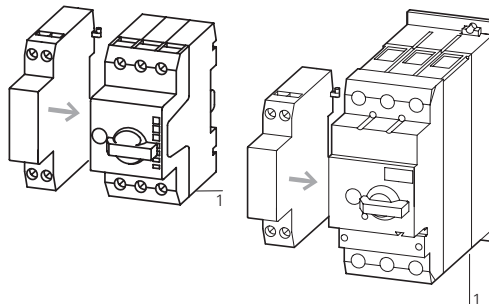

Accessories

- 1 Motor-protective circuit-breakers
- Further actuating voltages

Page











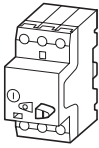

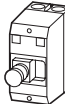
- 4
- 29

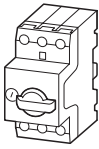
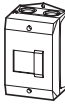
Can be fitted to the left side of motor-protective circuit-breakers.
Cannot be combined with:
A-PKZO shunt release
When combined with circuit-breaker, can be used as emergency switching off device to IEC/EN 60204.

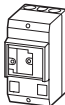
Max. rated operating voltage $U_n = 690$ V, rated uninterrupted current $I_n = 63$ A
Can be used for individual and group protection.
For group protection and in combination with PKZM4, order additional BK25/3 incoming terminal if required.
Mounting next to or behind the motor-protective circuit-breaker.
PKZM4: 16 - 63 A: 100 kA/400 V
PKZM4: 16 - 63 A: 10 kA/690 V

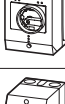
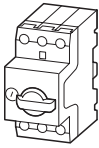
Engineering

PKZM01, PKZM

Part no.	Enclosure		Degree of protection	Handle color	Accessories							
	Part no.				NHI...PKZ0	AGM2...PKZ0	NHI-E...PKZ0	VHI...PKZ0	VHI...PKZ01	U-PKZ0 or A-PKZ0	L-PKZ0	
Surface mounting enclosure												
Motor-protective circuit-breaker PKZM01												
		CI-PKZ01	IP40	—	—	—	●	—	—	●	●	
					—	—	—	—	●	●	●	
					●	—	●	—	—	—	●	
					●	—	—	—	●	—	●	
		CI-PKZ01-G	IP65	—	—	—	●	—	—	●	●	
					—	—	—	—	●	●	●	
					●	—	●	—	—	—	●	
					●	—	—	—	●	—	●	
		CI-PKZ01-PVT CI-PKZ01-PVS	IP65	Red-yellow	—	—	●	—	—	●	●	
					—	—	—	—	●	●	●	
					—	—	—	—	—	●	●	
		CI-PKZ01-SVB CI-PKZ01-SVB-V	IP65	—	—	—	●	—	—	●	●	
					—	—	—	—	● ¹⁾	●	●	
					—	—	—	—	—	●	●	
Motor-protective circuit-breaker PKZM0												
		CI-K2-PKZ0	IP41	—	●	—	●	—	—	●	●	
					—	●	●	—	—	●	●	
					●	—	—	—	—	●	●	
					—	●	●	—	—	●	●	
		CI-K2-PKZ0-G	IP65	Black	●	—	●	—	—	●	●	
					—	●	●	—	—	●	●	
					●	—	—	—	—	●	●	
					—	●	●	—	—	●	●	
		CI-K2-PKZ0-GR	IP65	Red-yellow	●	—	●	—	—	●	●	
					—	●	●	—	—	●	●	
					—	—	—	—	—	●	●	
					—	—	—	—	—	●	●	
		CI-PKZ0-M	IP40	—	●	—	●	—	—	—	●	
					—	—	●	—	—	●	●	
					—	—	—	—	—	●	●	
					—	—	—	—	—	●	●	
		CI-PKZ0-GM	IP55	Black	●	—	●	—	—	—	●	
					—	—	●	—	—	●	●	
					—	—	—	—	—	●	●	
					—	—	—	—	—	●	●	
		CI-PKZ0-GRM	IP55	Red-yellow	●	—	●	—	—	—	●	
					—	—	●	—	—	—	●	
					—	—	—	—	—	●	●	
					—	—	—	—	—	●	●	
Motor-protective circuit-breaker PKZM0 + early-make auxiliary contact VHI-PKZ0												
		CI-K2-PKZ0-GV	IP65	Black	●	—	—	●	—	●	●	
					—	●	—	●	—	●	●	
					●	—	—	—	—	●	●	
					—	●	—	●	—	●	●	
		CI-K2-PKZ0-GRV	IP65	Red-yellow	●	—	—	●	—	●	●	
					—	●	—	●	—	●	●	
					—	—	—	—	—	●	●	
					—	—	—	—	—	●	●	
		CI-K2-PKZ0-GVM	IP55	Black	●	—	—	●	—	—	●	
					—	—	—	●	—	●	●	
					—	—	—	—	—	●	●	
					—	—	—	—	—	●	●	
		CI-K2-PKZ0-GRVM	IP55	Red-yellow	●	—	—	●	—	—	●	
					—	—	—	●	—	—	●	
					—	—	—	—	—	●	●	
					—	—	—	—	—	●	●	

Notes The combination possibilities of circuit-breakers in an enclosure with accessory modules are identified by a ●
¹⁾ Always required









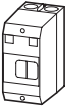

PKZM4, PKZM01, PKZM0

Enclosure		Accessories								
Part no.	Part no.	Degree of protection	Handle color	NHI...-PKZ0	AGM2...-PKZ0	NHI-E...-PKZ0	VHI...-PKZ0	VHI...-PKZ01	U-PKZ0 or A-PKZ0	L-PKZ0
Surface mounting enclosure										
Motor-protective circuit-breaker PKZM4										
	CI-K4-PKZ4-G	IP65	Black	●	●	●	-	-	●	●
	CI-K4-PKZ4-GR	IP65	Red-yellow	●	●	●	-	-	●	●
Installation enclosure										
Motor-protective circuit-breaker PKZM01										
	E-PKZ01	IP40	-	-	-	●	-	-	●	●
				●	-	●	-	●	●	●
	E-PKZ01-G	IP65	-	-	-	●	-	-	●	●
				●	-	●	-	●	●	●
	E-PKZ01-PVT	IP65	Red-yellow	-	-	●	-	-	●	●
	E-PKZ01-PVS	IP65	Red-yellow	-	-	-	-	●	●	●
	E-PKZ01-SVB	IP65	-	-	-	●	-	-	●	●
	E-PKZ01-SVB-V	IP65	-	-	-	-	-	● ¹⁾	●	●
Motor-protective circuit-breaker PKZM0										
	E-PKZ0	IP40	-	●	-	-	-	-	-	●
				-	-	-	-	-	●	●
	E-PKZ0-G	IP55	Black	●	-	●	-	-	-	●
				-	-	●	-	-	●	●
	E-PKZ1-GR	IP55	Red-yellow	●	-	●	-	-	-	●
				-	-	●	-	-	●	●

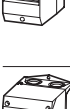
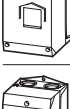
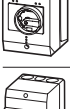
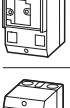



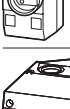
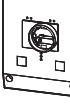











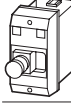

Notes

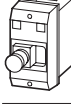
The combination possibilities of circuit-breakers in an enclosure with accessory modules are identified by a ●
¹⁾ Always required

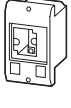





















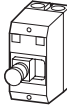







PKZM01, PKZM0, PKZM4

	Degree of protection	For use with	Part no. Article no.	Price See price list	Std. pack	Notes
Insulated enclosures for surface mounting						
For Motor-protective circuit-breaker PKZM01						
	–	IP40	PKZM01 +NHI-E or VHI-PKZ01 +U or A or NHI +L (2 off)	CI-PKZ01 281403	1 off	Integrated terminal for PE(N) connection, two M25 cable entry knockouts at top and at bottom.
	With operating membrane	IP65		CI-PKZ01-G 281404	1 off	
	Lockable in Off position	IP65	PKZM01 +NHI-E or +U or A +L (2 off)	CI-PKZ01-SVB 281405	1 off	
	Lockable in Off position in combination with VHI-PKZ01	IP65		CI-PKZ01-SVB-V 281944	1 off	
	With emergency switching off mushroom button, maintained	IP65		CI-PKZ01-PVT 281406	1 off	
	With emergency switching off mushroom button, with key-release	IP65		CI-PKZ01-PVS 281407	1 off	
	For extension with inserts CI/E-PKZ01-X... unit	As insert	PKZM01	CI-PKZ01-X 289934	1 off	
For Motor-protective circuit-breakers PKZM0						
	Cover with aperture dimensioned to accommodate front of breaker. IP40, when mounted turned through 90° to left/right	IP41 with vertical mounting	PKZM0-... +NHI or AGM +U or A +NHI-E +L-PKZ0 (2 off)	CI-K2-PKZ0 219653	1 off	M25 metric cable entry knockout, top and bottom Cable push-through membrane top, bottom, in the back plate and as a control line entry. Insulated enclosure CI-K2 incl. N and PE terminal.
	With black-grey rotary knob	IP65		CI-K2-PKZ0-G 219654	1 off	
	With red-yellow rotary knob, for use as emergency switching off device to EN 60204	IP65		CI-K2-PKZ0-GR 219655	1 off	
	Cover with aperture dimensioned to accommodate front of breaker	IP40	PKZM0-... +NHI or U or A +L-PKZ0 (2 off)	CI-PKZ0-M 267083	1 off	Integrated terminal for PE(N) connection, two M25 cable entry knockouts at top and at bottom.
	With black-grey rotary knob	IP55	PKZM0-... +NHI-E +NHI or U or A +L-PKZ0 (2 off)	CI-PKZ0-GM 260089	1 off	
	With red-yellow rotary knob, for use as emergency switching off device to EN 60204	IP55		CI-PKZ0-GRM 260104	1 off	
For Motor-protective circuit-breakers PKZM0 with early-make VHI auxiliary contacts						
	With black-grey rotary knob	IP65	PKZM0-... and VHI +NHI or AGM +U or A +L (2 off)	CI-K2-PKZ0-GV 219657	1 off	M25 metric cable entry knockout, top and bottom Cable push-through membrane top, bottom, in the back plate and as a control line entry. Insulated enclosure CI-K2 incl. N and PE terminal.
	With red-yellow rotary knob, for use as emergency switching off device to EN 60204	IP65		CI-K2-PKZ0-GRV 219656	1 off	
	With black-grey rotary knob	IP55	PKZM0-... and VHI +U or A (undervoltage or shunt release) +L-PKZ0 (2 off)	CI-PKZ0-GVM 263526	1 off	Integrated terminal for PE(N) connection, two M25 cable entry knockouts at top and at bottom.
	With red-yellow rotary knob, for use as emergency switching off device to EN 60204	IP55		CI-PKZ0-GRVM 263525	1 off	
For Motor-protective circuit-breakers PKZM4						
	With black-grey rotary knob	IP65	PKZM4-... +VHI or NHI-E +NHI and AGM +U or A +L-PKZ0 (2 off)	CI-K4-PKZ4-G 225524	1 off	Metric knockout: Top and bottom: M25/M32 In the back plate: M25/M32 Control cable entry: M20 CI-K4 insulated enclosure including insulated PE terminal
	With red-yellow rotary knob, for use as emergency switching off device to EN 60204	IP65		CI-K4-PKZ4-GR 225525	1 off	













E-PKZ

	Degree of protection	For use with	Part no. Article no.	Price See price list	Std. pack	Information relevant for export to North America
Insulated enclosures for flush mounting						
For Motor-protective circuit-breaker PKZM01						
Integrated terminal for PE(N) connection.						
	Front IP40	PKZM01 +NHI or U or A +NHI-E or VHI +L (2 off)	E-PKZ01 281633		1 off 	Product Standards UL 508; CSA-C22.2 No.14; IEC60947-4-1; CE marking E36332 NLRV 12528 3211-05 UL Listed, CSA certified
	With operating membrane Front IP65		E-PKZ01-G 281634		1 off 	UL File No. UL CCN CSA File No. CSA Class No. NA Certification
	Lockable in Off position Front IP65	PKZM01 +U or A +NHI-E	E-PKZ01-SVB 281635		1 off 	
	Lockable in Off position, in combination with VHI-PKZ01 Front IP65	PKZM01 +U or A +NHI-E or VHI	E-PKZ01-SVB-V 281943		1 off 	
	With emergency switching off mushroom button, maintained Front IP65		E-PKZ01-PVT 281636		1 off 	
	With emergency switching off mushroom button, with key-release Front IP65		E-PKZ01-PVS 281637		1 off 	
	For extension with inserts CI/E-PKZ01-X... unit As insert	PKZM01	E-PKZ01-X 289935		1 off	
For Motor-protective circuit-breakers PKZM0						
Integrated terminal for PE(N) connection.						
	Cover with aperture dimensioned to accommodate front of breaker Front IP40	PKZM0-... +NHI or U or A +L-PKZ0 (2 parts)	E-PKZ0 072906		1 off 	Product Standards UL 508; CSA-C22.2 No.14; IEC60947-4-1; CE marking E36332 NLRV 12528 3211-05 UL Listed, CSA certified
	With black-grey rotary knob Front IP55	PKZM0-... +NHI or U or A +NHI-E +L-PKZ0 (2 parts)	E-PKZ0-G 072907		1 off 	Product Standards UL 508; CSA-C22.2 No.14; IEC60947-4-1; CE marking E36332 NLRV 12528 3211-05 UL Listed, CSA certified
	With red-yellow rotary knob, for use as emergency switching off device to EN 60204 Front IP55		E-PKZ0-GR 072908		1 off 	UL File No. UL CCN CSA File No. CSA Class No. NA Certification Degree of Protection IEC: Front IP55, UL/CSA Type: 1,12, 3R

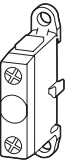
CI-PKZ

	Degree of protection	For use with	Part no. Article no.	Price See price list	Std. pack	Information relevant for export to North America
Insulated enclosures for surface mounting						
For Motor-protective circuit-breaker PKZM01						
Integrated terminal for PE(N) connection.						
	IP41	PKZM01 +NHI-E or VHI-PKZ01 +U or A or NHI +L (2 off)	CI-PKZ01-NA 281408		1 off  	Product Standards UL 508; CSA-C22.2 No.14; IEC60947- 4-1; CE marking UL File No. E36332 UL CCN NLRV CSA File No. 12528 CSA Class No. 3211-05 NA Certification UL Listed, CSA certified Specially designed for NA ✓ Degree of Protection IEC: IP41, UL/CSA Type: -
	With operating membrane IP65	PKZM01 +NHI-E or VHI-PKZ01 +U or A or NHI +L (2 off)	CI-PKZ01-NA-G 281409		1 off  	Product Standards UL 508; CSA-C22.2 No.14; IEC60947- 4-1; CE marking UL File No. E36332 UL CCN NLRV CSA File No. 12528 CSA Class No. 3211-05 NA Certification UL Listed, CSA certified Specially designed for NA ✓ Degree of Protection IEC: IP65, UL/CSA Type: -
	Lockable in Off position IP65	PKZM01 +NHI-E or VHI-PKZ01 +U or A +L (2 off)	CI-PKZ01-NA-SVB 281630		1 off  	Product Standards UL 508; CSA-C22.2 No.14; IEC60947- 4-1; CE marking UL File No. E36332 UL CCN NLRV CSA File No. 12528 CSA Class No. 3211-05 NA Certification UL Listed, CSA certified Specially designed for NA ✓ Degree of Protection IEC: IP65, UL/CSA Type: -
	Lockable in Off position, in combination with VHI-PKZ01 IP65	PKZM01 +NHI-E +U or A +L (2 off)	CI-PKZ01-NA-SVB-V 281945		1 off  	
	With emergency switching off mushroom button, maintained IP65		CI-PKZ01-NA-PVT 281631		1 off  	
	With emergency switching off mushroom button, with key-release IP65		CI-PKZ01-NA-PVS 281632		1 off  	
For Motor-protective circuit-breakers PKZM0						
Integrated N and PE terminals; lower section without knockouts						
	With black-grey rotary knob IP55	PKZM0-... +NHI or U or A +NHI-E +L-PKZ0 (2 parts)	CI-K2-PKZ0-NA-G 262680		1 off  	Product Standards UL 508; CSA-C22.2 No.14; IEC60947- 4-1; CE marking UL File No. E36332 UL CCN NLRV CSA File No. 12528 CSA Class No. 3211-05 NA Certification UL Listed, CSA certified Specially designed for NA ✓ Degree of Protection IEC: IP55, UL/CSA Type: 1, 12, 3R
	With red-yellow rotary knob, for use as emergency switching off device to EN 60204 IP55		CI-K2-PKZ0-NA-GR 262681		1 off  	
For Motor-protective circuit-breakers PKZM0 with early-make auxiliary contacts						
Integrated N and PE terminals; lower section without knockouts						
	With black-grey rotary knob IP55	PKZM0-... +VHI... + U... +L-PKZ0 (2 parts)	CI-K2-PKZ0-NA-GV 262682		1 off  	
	With red-yellow rotary knob, for use as emergency switching off device to EN 60204 IP55		CI-K2-PKZ0-NA-GRV 262683		1 off  	

SVB-PKZ, CL/EPKZ01

	Degree of protection	For use with	Part no. Article no.	Price See price list	Std. pack	Information relevant for export to North America 
Insulated enclosures, accessories						
Padlocking feature						
For up to 3 padlocks with 3 – 6 mm hasp thickness, for use as main switch to IEC/EN60204						
	Lockable in the 0-position of the PKZM0 or Motor-protective circuit-breaker PKZM4.	–	CI-K2-PKZ0-G(R)(V) CI-PKZ0-G(R)(V)M	SVB-PKZ0-CI 035129	3 off 	Product Standards UL 508; CSA-C22.2 No.14; IEC60947-4-1; CE marking UL File No. UL CCN CSA File No. CSA Class No. NA Certification E36332 NLRV 12528 3211-05 UL Listed, CSA certified
	–	–	E-PKZ0-G(R)	SVB-PKZ0-E 035127	3 off 	
	–	–	CI-K4-PKZ4-G(R)	SVB-PKZ4-CI 225526	1 off	
Neutral terminal						
For connection of a 5th conductor						
	Flexible, 1 - 4 mm ²	–	CI-K2-PKZ0-...	K-CI-K1/2 207451	20 off 	UL/CSA certification not required
	63 A, flexible, 6 - 16 mm ²	–	CI-K4-PKZ4-G(R)	K25/1 096200	10 off	
	–	–	E-PKZ0(-G)(-GR) E-PKZ01(-G)	N-PKZ0 082160	20 off	
Units for insulated enclosures for PKZ01						
Combinable with CI-PKZ01-X and E-PKZ01-X.						
	With operating membrane	Front IP65	PKZM01 +NHI-E or VHI-PKZ01 +U or A or NHI +L (2 off)	CI/E-PKZ01-XG 289936	1 off	
	Lockable in Off position	Front IP65	PKZM01 +NHI-E +U or A +L (2 off)	CI/E-PKZ01-XSVB 289939	1 off	
	With emergency switching off mushroom button, maintained	Front IP65	PKZM01 +NHI-E or VHI-PKZ01 +U or A +L (2 off)	CI/E-PKZ01-XPVT 289937	1 off	
	With emergency switching off mushroom button, with key-release	Front IP65	PKZM01 +NHI-E or VHI-PKZ01 +U or A +L (2 off)	CI/E-PKZ01-XPVS 289938	1 off	
	Lockable in Off position, in combination with VHI-PKZ01	Front IP65	PKZM01 VHI-PKZ01 +U or A +L (2 off)	CI/E-PKZ01-XSVB-V 289980	1 off	

Accessories

Metric cable glands to EN 50262

- With lock nut and built-in strain relief
- IP68 up to 5 bar, halogen free

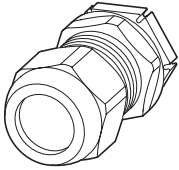

Metric diaphragm grommets



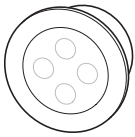

















- IP66
- With integral push-through diaphragm



Cable entry	Drilling dimensions mm	External cable diameter mm	Part no. Article no.	Price See price list	Std. pack
M20	20.5	6 - 13	V-M20 206910		20 off
M25	25.5	9 - 17	V-M25 206911		20 off
M32	32.5	13 - 21	V-M32 206912		10 off
M32	32.5	18 - 25	V-M32G 226156		10 off
M20	20.5	1 - 13	KT-M20 207602		100 off
M25	25.5	1 - 18	KT-M25 207603		100 off
M32	32.5	1 - 25	KT-M32 207604		100 off

Door coupling handles
Degree of protection IP65, UL/CS Type 4X / Type12



For use with	Part no. Article no.	Price See price list	Std. pack	Notes
For use as main switch to IEC/EN 60204	Black PKZM0 PKZM4 PKZ0-XH¹⁾ 106132	1 off  	Pluggable PKZ0-XAH extension shaft, can be cut to any required length for installation depths of 100...240 mm.	
For use as a main switch with emergency switching off function to EN 60204	Red-yellow PKZM0 PKZM4 PKZ0-XRH¹⁾ 106133	1 off  	Follower included in delivery.	
For use as a main switch to EN 60204 in MCC power distribution systems and with PKZM0 installed rotated by 90°	Black PKZM0 PKZM4 PKZ0-XH-MCC¹⁾ 106136	1 off  	With ON/OFF switch position and "+" (tripped), lockable	
For use as a main switch with emergency switching off function to EN 60204 in MCC power distribution systems and with PKZM0 installed rotated by 90°	Red-yellow PKZM0 PKZM4 PKZ0-XRH-MCC¹⁾ 106137	1 off  	With 3 padlocks, 4 – 8 mm hasp. Cannot be used in combination with VH20-PKZ0.	
For use as main switch to IEC/EN 60204	Black PKE PKE-XH¹⁾ 142416	1 off  	Pluggable PKZ0-XAH extension shaft, can be cut to any required length for installation depths of 100...240 mm.	
For use as a main switch with emergency switching off function to EN 60204	Red-yellow PKE PKE-XRH¹⁾ 142417	1 off  	Follower included in delivery.	
For use as a main switch to EN 60204 in MCC power distribution systems and with PKE installed rotated by 90°	Black PKE PKE-XH-MCC¹⁾ 142418	1 off  	With ON/OFF switch position and "+" (tripped), lockable	
For use as a main switch with emergency-switching off function to EN 60204 in MCC power distribution systems and with PKE installed rotated by 90°	Red-yellow PKE PKE-XRH-MCC¹⁾ 142419	1 off  	With 3 padlocks, 4 – 8 mm hasp.	
For increasing the degree of protection of the PKZM4 to IP2X	– PKZM4 HB-PKZ4²⁾ 256581	1 off  	Suitable for connecting cables with a max. external diameter of 9.5 mm	
–	– PKZM0 PKZM4 PKZ0-XAH¹⁾ 106134	1 off  	Follower not included	

Information relevant for export to North America



1) Product Standards	UL 508; CSA-C22.2 No.14; IEC60947-4-1; CE marking
UL File No.	E36332
UL CCN	NLRV
CSA File No.	12528
CSA Class No.	3211-05
NA Certification	UL Listed, CSA certified
Degree of Protection	IEC: IP65, UL/CSA Type: 4X, 12

2) Product Standards	UL 508; CSA-C22.2 No.14; IEC60947-4-1; CE marking
UL File No.	E36332
UL CCN	NLRV
CSA File No.	12528
CSA Class No.	3211-05
NA Certification	UL Listed, CSA certified

Accessories

Telescopic adapters With 45 mm top-hat rail to IEC/EN 60715 for compensation of the mounting depth of rear-mounted devices enclosures CI-K and cabinets

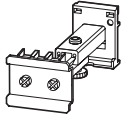

Notes	Part no. Article no.	Price See price list	Std. pack	Information relevant for export to North America
Telescopic clip Stepless adjustment via scale from 75 – 115 mm.	M22-TA 226161		1 off 	Product Standards IEC/EN60947-5; UL 508; CSA-C22.2 No.14-05; CSA-C22.2 No.94-91; CE marking E29184 UL File No. UL CCN CSA File No. 012528 CSA Class No. 3211-03 NA Certification UL Listed, CSA certified

Lockable rotary handle



For locking motor-protective circuit-breakers PKZM0, PKZM4 and PKE as a main switch in compliance with EN 60204. Can be padlocked in the "0" position. Hasp thickness: 3 – 6.35 mm	Can not be combined with VHI-PKZ0.	AK-PKZ0 030851	5 off 	Product Standards UL 508; CSA-C22.2 No.14; IEC/EN 60947-4-1; CE marking E36332 UL File No. UL CCN CSA File No. 12528 CSA Class No. 3211-05 NA Certification UL Listed, CSA certified
---	------------------------------------	--------------------------	-----------	--

Holding facility

To prevent tampering with the overload release and the test function, it can be sealed using industry standard sealing wire For use with motor-protective circuit-breakers PKZM0 and PKZM4	–	PL-PKZ0 203599	5 off	
---	---	--------------------------	-------	--

Mounting angle bracket



For screw fixing to mounting plate	–	PKE32-XMB 134837	20 off 	Product Standards UL 508; CSA-C22.2 No.14; IEC/EN 60947-4-1; CE marking NA Certification Request filed for UL and CSA
------------------------------------	---	----------------------------	------------	--

Documentation

Motor-protective circuit-breakers PKZM0, overload monitoring of EEx e motors	German/English	AWB1210-1458D/GB 266164	1 off	
Motor-protective circuit-breakers PKZM4, overload monitoring of EEx e motors	German/English	AWB1210-1457D/GB 266165	1 off	
Motor-protective circuit-breakers PKE, EEx electric motor overload monitoring	German/English	AWB1210-1631DE/EN 134836	1 off	

Indicator lights with glow lamp











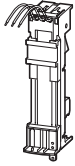

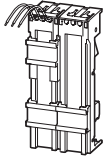
For use with	Color	Voltage U _s V	Part no. Article no.	Price See price list	Std. pack
CI-K2-PKZ0-..., CI-K4-PKZ4, CI-PKZ0(1), E-PKZ0(1)	White	110 - 230	L-PKZ0(230V) 082151		10 off
CI-K2-PKZ0-..., CI-K4-PKZ4, CI-PKZ0(1), E-PKZ0(1)	White	230 - 400	L-PKZ0(400V) 082152		10 off
CI-K2-PKZ0-..., CI-K4-PKZ4, CI-PKZ0(1), E-PKZ0(1)	White	415 - 500	L-PKZ0(500V) 082153		5 off
CI-K2-PKZ0-..., CI-K4-PKZ4, CI-PKZ0(1), E-PKZ0(1)	Green	110 - 230	L-PKZ0-GN(230V) 082154		10 off
CI-K2-PKZ0-..., CI-K4-PKZ4, CI-PKZ0(1), E-PKZ0(1)	Green	230 - 400	L-PKZ0-GN(400V) 082155		10 off
CI-K2-PKZ0-..., CI-K4-PKZ4, CI-PKZ0(1), E-PKZ0(1)	Green	415 - 500	L-PKZ0-GN(500V) 082156		5 off
CI-K2-PKZ0-..., CI-K4-PKZ4, CI-PKZ0(1), E-PKZ0(1)	Red	110 - 230	L-PKZ0-RT(230V) 082157		10 off
CI-K2-PKZ0-..., CI-K4-PKZ4, CI-PKZ0(1), E-PKZ0(1)	Red	230 - 400	L-PKZ0-RT(400V) 082158		10 off

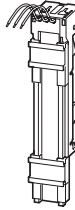
Busbar adapters for PKZ and PKE

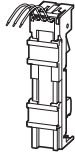
Approved to **UL508**.

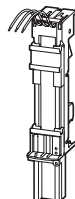
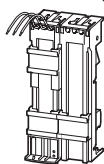
For fitting to flat copper busbars with 60mm between busbar centers, suitable for 5 mm and 10 mm busbar thickness.

Rated operational voltage U_e V	Conductor cross-section	Adapter width mm	Mounting rails Number	For use with	Part no. Article no.	Price See price list	Std. pack	Notes				
Rated operational current 16 A For starters with spring-loaded terminals 	690	AWG 14 (2.5 mm ²)	45	2	PKZM0-C + DILMC7 PKZM0-C + DILMC9 PKZM0-C + DILMC12	BBA0C-16 101455	4 off  	According to UL 508: $I_e = 12$ A				
	Rated operational current 25 A For reversing starters 	690	AWG 12 (4 mm ²)	90	1	PKZM0, PKE + 2 x DILM7-01 PKZM0, PKE + 2 x DILM9-01 PKZM0, PKE + 2 x DILM12-01 MSC-R-0,25-M7... - MSC-R-12-M12...	BBA0R-25 101453	2 off  	In combination with individual components PKZM0 and DILM, use reversing starter kit PKZM0-XRM12. Fully assembled and tested combination with MSC-R			
		Can be used universally 	690	AWG 12 (4 mm ²)	45	2	—	BBA0-25/2TS 101481	4 off  	Mounting rails can be moved within 1.25 mm grid.		
			For DOL starters 	690	AWG 12 (4 mm ²)	45	1	PKZM0, PKE + 2 x DILM17-01 PKZM0, PKE + 2 x DILM25-01 PKZM0, PKE + 2 x DILM25-01 PKZM0, PKE + 2 x DILM32-01 MSC-R-16-M17... MSC-R-32-M32...	BBA0-25 101451	4 off  	In combination with individual components PKZM0 and DILM, use DOL starter kit PKZM0-XRM12. Fully assembled and tested combination with MSC-D	
				For soft starters 	690	AWG 12 (4 mm ²)	45	1	PKZM0, PKE + DS7...004N... PKZM0, PKE + DS7...007N... PKZM0, PKE + DS7...009N... PKZM0, PKE + DS7...012N...	BBA0L-25 142526	1 off	—
					Rated operational current 32 A For reversing starters 	690	AWG 10 (6 mm ²)	90	3	PKZM0, PKE + 2 x DILM17-01 PKZM0, PKE + 2 x DILM25-01 PKZM0, PKE + 2 x DILM32-01 MSC-R-16-M17... - MSC-R-32-M32...	BBA0R-32 101454	2 off  

Information relevant for export to North America









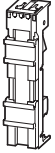

Product Standards

UL File No.
UL CCN

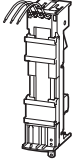
UL 508A; CSA-C22.2 No. 14;
IEC60439-1; CE marking
E300273
NMTR, NMTRZ

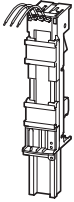
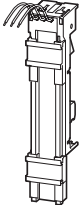
CSA File No.
CSA Class No.
NA Certification
Max. Voltage Rating

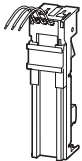
232140
3211-37
UL Listed, CSA certified
600 V AC

	Rated operational voltage U_e V	Conductor cross-section	Adapter width mm	Mounting rails Number	For use with	Part no. Article no.	Price See price list	Std. pack	Notes
<p>Rated operational current 32 A Can be used universally.</p> 	690	–	45	2	PKZM0..., PKE + DILM...	BBA0-32/2TS-C2²⁾ 116708		4 off 	Universal adapter 1-, 2- and 3-phase applications. Mounting rail can be moved within 1.25 mm grid. For conductor cross-sections, round conductors of up to 6 mm ² . Only busbaradapters/wiring sets manufactured on or after CW 35/2009 can be used for PKE.
<p>For DOL starters.</p> 	690	AWG 10 (6 mm ²)	45	2	PKZM0, PKE + DILM17 PKZM0, PKE + DILM25 PKZM0, PKE + DILM32 MSC-D-16-M17... - MSC-D-32-M32...	BBA0-32¹⁾ 101452		4 off 	In combination with individual components PKZM0 and DILM wiring kit PKZM0-XM32DE can be used. Fully assembled and tested combination with MSC-D
<p>For soft starters</p> 	690	AWG 10 (6 mm ²)	45	2	PKZM0, PKE + DS7...016N... PKZM0, PKE + DS7...024N... PKZM0, PKE + DS7...032N...	BBA0L-32 142527		1 off	–
<p>For 160 mm adapter system with motor-protective circuit-breakers</p>	690	AWG 10 (6 mm ²)	45	1	PKZM0, PKE	BBA0K-32 142528		1 off	–
<p>Rated operational current 63 A For DOL starters.</p> 	690	AWG 8 (10 mm ²)	55	2	PKZM4 + DILM17 PKZM4 + DILM25 PKZM4 + DILM32 PKZM4 + DILM40 PKZM4 + DILM50 PKZM4 + DILM65	BBA4-63¹⁾ 101459		4 off 	The following can be used to establish an electrical connection: For PKZM4 + DILM17 to DILM32: MVS-LB0-0M-G For PKZM4 + DILM40 to DILM65: PKZM4-XM65DE.
<p>For motor-protective circuit-breakers</p> 	690	AWG 8 (10 mm ²)	54	1	PKZM4	BBA4-63¹⁾ 101457		4 off 	–

Information relevant for export to North America



1)

Product Standards	UL 508; CSA-C22.2 No.14; IEC60439-1; CE marking
UL File No.	E300273
UL CCN	NMTR, NMTR7
CSA File No.	232140
CSA Class No.	3211-37
NA Certification	UL Listed, CSA certified
Max. Voltage Rating	600 V AC

2)

Product Standards	UL 508; CSA-C22.2 No.14; IEC60439-1; CE marking
UL File No.	E300273
UL CCN	NMTR, NMTR7
NA Certification	UL Listed, CSA certified
Max. Voltage Rating	600 V AC











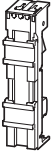





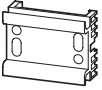

1.1

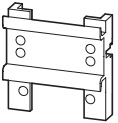
Motor-protective circuit-breakers PKZM01, PKZM0, PKZM4, PKE

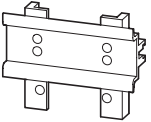
Busbar adapters

1

BBA, PKZM0-XM

	Rated operational voltage U_e V	Conductor cross-section	Adapter width mm	Mounting rails Number	For use with	Part no. Article no.	Price See price list	Std. pack	Notes
Without electrical contacts Empty module. 	–	–	45	2	–	BBA0/ZTS-L¹⁾ 101482		4 off  	Mounting rails can be moved within a 1.25 mm grid. Can be used to mount reversing and star-delta starters.
	–	–	54	2	–	BBA4/ZTS-L¹⁾ 101483		4 off  	Mounting rails can be moved within a 1.25 mm grid. Can be used to mount reversing and star-delta starters.
Side-mounted module, can be attached on both sides. 	–	–	9	–	–	BBA-XSM¹⁾ 101484		10 off  	Can be grouped with busbar adapters in order to extend the mounting width.
Busbar adapters accessories Mounting rails 	–	–	45	–	BBA...	PKZM0-XMR²⁾ 239364		10 off  	–
Busbar adapters accessories Mounting rails 	–	–	54	–	BBA...	PKZM0-XMR54²⁾ 113911		10 off  	–
Busbar adapters accessories Mounting rails 	–	–	72	–	BBA...	PKZM0-XMR72²⁾ 113912		10 off  	–
Connecting cable –	–	–	–	–	BBA...	BBA-XLT-6-130³⁾ 116902		30 off  	–
	–	–	–	–	BBA...	BBA-XLT-16-142³⁾ 116903		30 off  	–

Information relevant for export to North America



1)

Product Standards	UL 508A; CSA-C22.2 No.14; IEC60439-1; CE marking
UL File No.	E300273
UL CCN	NMTR, NMTR7
CSA File No.	232140
CSA Class No.	3211-37
NA Certification	UL Listed, CSA certified
Max. Voltage Rating	600 V AC

2)

Product Standards	UL 508A; CSA-C22.2 No.14; IEC60947-4-1; CE marking
UL File No.	E300273
UL CCN	NMTR, NMTR7
CSA File No.	232140
CSA Class No.	3211-37
NA Certification	UL Listed, CSA certified

3)

Product Standards	UL 508A; CSA-C22.2 No.14; IEC60439-1; CE marking
UL File No.	On request
UL CCN	On request
CSA File No.	On request
CSA Class No.	On request
NA Certification	UL Recognized, CSA certified

Wiring set

For use with

Part no.
Article no.

Price
See price list

Std. pack

Notes

DOL starter

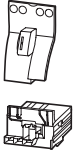

PKZM0, PKE + DILM7
PKZM0, PKE + DILM9
PKZM0, PKE + DILM12
PKZM0, PKE + DILM15
DS7-34...SX004...
DS7-34...SX007...
DS7-34...SX009...
DS7-34...SX012...

PKZM0-XDM12
283149

1 off
 

Consists of:

- Mechanical connection element for PKZM0 and contactor
- Main supply wiring between PKZM0 and contactor with tool-less plug connection
- Cable routing

As auxiliary contact, use DILA-XHIT... → See DILA catalog
Cannot be combined with NHI-E...PKZ0-C.
 $U_e \leq 415\text{ V}$

DOL starter

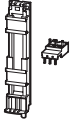

PKZM0, PKE + DILM17
PKZM0, PKE + DILM25
PKZM0, PKE + DILM32

PKZM0-XDM32
283153

1 off
 

Consists of:

- Top-hat rail adapter plates
- Power supply wiring between PKZ and contactor

PKZM4 + DILM40
PKZM4 + DILM50
PKZM4 + DILM65

PKZM4-XDM65
101053

1 off
 

Reversing starters

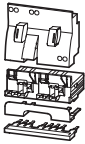

PKZM0, PKE + DILM7-01
PKZM0, PKE + DILM9-01
PKZM0, PKE + DILM12-01

PKZM0-XRM12
283185

1 off
 

Consists of:

- Mechanical connection element for PKZM0 and contactor
- Reversing starters main supply wiring with tool-less plug connection
- Control cables for electrical interlocking in tool-less plug connection:
 - K1M: A1 -K2M: 21
 - K1M: 21 -K2M: A1
 - K1M: A2 -K2M: A2
- Cable routing

As auxiliary contact DILA-XHIT...use → See DILA catalog
Can not be combined with AGM - PKZ0.
 $U_e \leq 415\text{ V}$

Reversing starters

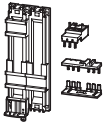

PKZM0, PKE + DILM17
PKZM0, PKE + DILM25
PKZM0, PKE + DILM32

PKZM0-XRM32
283189

1 off
 

Consists of:

- Top-hat rail adapter plates
- Reversing starters supply wiring

Wiring kit



PKZM0, PKE + DILM17
PKZM0, PKE + DILM25
PKZM0, PKE + DILM32
DS7-34...SX016...
DS7-34...SX024...
DS7-34...SX032...

PKZM0-XM32DE
239349

5 off
 

• Main supply wiring between PKZM0 and contactor
• Use only in combination with busbar adapter or mounting rail adapter plate

PKZM4 + DILM40
PKZM4 + DILM50
PKZM4 + DILM65

PKZM4-XM65DE
101056

5 off
 

• Main current supply between PKZM4 and contactor

Top-hat rail adapter plates



PKZM0-XDM12
PKZM0-XRM12

PKZM0-XC45
283132

4 off
 

Consists of:

- 45 mm wide adapter plate
- Connection element for side-by-side positioning of further plates

Top-hat rail adapter plates



PKZM4 + DILM40
PKZM4 + DILM50
PKZM4 + DILM65

PKZM4-XC55/2
101054

4 off
 

Consists of:

- 55 mm wide adapter plate
- Connection cam for additional plates
- For use with reversing and start-delta starters

Soft starters



PKZM0, PKE + DS7...004N...
PKZM0, PKE + DS7...007N...
PKZM0, PKE + DS7...009N...
PKZM0, PKE + DS7...012N...

PKZM0-XC45L
142529

1 off

Consists of:

- 45 mm wide adapter plate

Soft starters

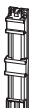

PKZM0, PKE + DS7...016N...
PKZM0, PKE + DS7...024N...
PKZM0, PKE + DS7...032N...

PKZM0-XC45L/2
142570

1 off

Consists of:

- 45 mm wide adapter plate

1

Description

For use with

Part no.
Article no.

Price
See price list

Std. pack

Notes

Information relevant for export to North America

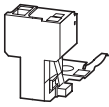

PE module with contact plate

DILM(C)7 DILM(C)9 DILM(C)12 DILM(C)15	DILM12-XMCE 121764	5 off 	35 x 7.5 (15) mm mounting rail (as per DIN EN 60715) with PE function required. For connection of: PE 0.75 – 4 mm ²	Product Standards NA Certification	UL 508; CSA-C22.2 No. 14; IEC60947-4-1; CE marking Request filed for UL and CSA
--	------------------------------	-----------	--	---------------------------------------	--

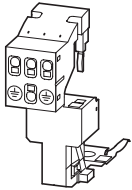

Motor feeder plug with PE module and contact plate

DILM(C)7 DILM(C)9 DILM(C)12 DILM(C)15	DILM12-XMCP/E 121769	1 off 	35 x 7.5 (15) mm mounting rail (as per DIN EN 60715) with PE function required. For connection of: L1, L2, L3, PE 0.75 – 2.5 mm ²	Product Standards NA Certification	IEC/EN 60947-4-1; UL 508; CSA-C22.2 No. 14-05; CE marking Request filed for UL and CSA
--	--------------------------------	-----------	--	---------------------------------------	---



Motor feeder plug with PE module without contact plate

PKZM0/PKE + DILM(C)7 PKZM0/PKE + DILM(C)9 PKZM0/PKE + DILM(C)12 PKZM0/PKE + DILM(C)15 MSC-D(E)-...-M7... MSC-D(E)-...-M9... MSC-D(E)-...-M15...	DILM12-XMCP/T 121770	1 off 	For connection of: L1, L2, L3, PE 0.75 – 2.5 mm ²	Product Standards NA Certification	IEC/EN 60947-4-1; UL 508; CSA-C22.2 No. 14-05; CE marking Request filed for UL and CSA
---	--------------------------------	-----------	--	---------------------------------------	---

Three-phase commoning links, incoming unit via terminals 1, 3, and 5

Finger- and back-of-hand-proof, short-circuit proof, $U_e=690\text{ V}$, $I_n=63\text{ A}$
Can be extended through rotated installation

Circuit-breakers Number	Length mm	Unit width mm	Part no. Article no.	Price See price list	Std. pack	Notes
-------------------------	-----------	---------------	----------------------	----------------------	-----------	-------

For PKZM0... or PKE without side-mounted auxiliary contacts or voltage releases

	2	90	45	B3.0/2-PKZ0¹⁾ 063961	10 off 	For parallel feeding of multiple motor-protective circuit-breakers on terminals 1, 3, and 5
	3	135	45	B3.0/3-PKZ0¹⁾ 232289	10 off 	
	4	180	45	B3.0/4-PKZ0¹⁾ 063960	10 off 	
	5	225	45	B3.0/5-PKZ0¹⁾ 232290	10 off 	

For motor-protective circuit-breakers with one auxiliary contact or trip-indicating auxiliary contact each fitted to right side

	2	99	45 + 9	B3.1/2-PKZ0¹⁾ 044945	10 off 	For parallel feeding of multiple motor-protective circuit-breakers on terminals 1, 3, and 5
	3	153	45 + 9	B3.1/3-PKZ0¹⁾ 044946	10 off 	
	4	207	45 + 9	B3.1/4-PKZ0¹⁾ 044947	10 off 	
	5	261	45 + 9	B3.1/5-PKZ0¹⁾ 044948	10 off 	

For PKZM0... or PKE with one auxiliary contact or trip-indicating auxiliary contact each fitted to right side, or one voltage release fitted on left side

	2	108	45 + 18	B3.2/2-PKZ0¹⁾ 063963	10 off 	For parallel feeding of multiple motor-protective circuit-breakers on terminals 1, 3, and 5
	4	234	45 + 18	B3.2/4-PKZ0¹⁾ 063959	10 off 	

Information relevant for export to North America



1) Product Standards	UL 508A; CSA-C22.2 No.14; IEC60947-4-1; CE marking
UL File No.	E36332
UL CCN	NLRV
CSA File No.	98494
CSA Class No.	3211-06
NA Certification	UL Listed, CSA certified

HB3...PKZO, BK...I3-PKZ

Circuit-breakers	For use with	Unit width	Part no. Article no.	Price See price list	Std. pack	Notes
------------------	--------------	------------	-------------------------	-------------------------	-----------	-------

Number	mm
--------	----

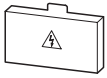

Shroud for unused terminals

Protection against direct contact.

For covering unused terminals on three-phase commoning link B3...-PKZO

-	-	-	H-B3-PKZO¹⁾ 032721		20 off 	-
---	---	---	---	--	------------	---

Incoming terminals

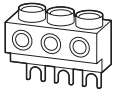

-	PKZM0 PKE	-	BK25/3-PKZO²⁾ 032720		5 off 	For three-phase commoning link, protected against accidental contact, $U_e = 690\text{ V}$, $I_u = 63\text{ A}$ For conductor cross-sections: 2.5 - 25 mm ² stranded 2.5 - 16 mm ² flexible with ferrule AWG 14 - 6, usable on terminals 1, 3, and 5
---	--------------	---	---	--	-----------	---

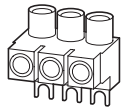

-	PKZM0	-	BK25/3-PKZO-E³⁾ 262518		5 off 	For three-phase commoning link, protected against accidental contact, $U_e = 690\text{ V}$, $I_u = 60\text{ A}$ For conductor cross-sections: 2.5 - 25 mm ² stranded 2.5 - 16 mm ² flexible with ferrule AWG 14 - 6 For assembly of Type E starters.
---	-------	---	---	--	-----------	--

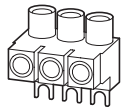

-	PKZM4	-	BK50/3-PKZ4-E⁴⁾ 272165		1 off 	Can be combined with three-phase commoning link B3...PKZ4. $I_u = 120\text{ A}$. For assembly of Type E starters.
---	-------	---	---	--	-----------	--

Information relevant for export to North America



1)
Product Standards UL 508; CSA-C22.2 No.14; IEC60947-4-1;
CE marking
UL File No. E36332
UL CCN NLRV
CSA File No. 98494
CSA Class No. 3211-06
NA Certification UL Listed, CSA certified

2)
Product Standards UL 508; CSA-C22.2 No.14; IEC60947-4-1;
CE marking
UL File No. E36332
UL CCN NLRV
CSA File No. 12528
CSA Class No. 3211-05
NA Certification UL Listed, CSA certified

3)
Product Standards UL 508; CSA-C22.2 No.14; IEC60947-4-1;
CE marking
UL File No. E36332
UL CCN NLRV
CSA File No. 98494
CSA Class No. 3211-06
NA Certification UL Listed, CSA certified
Specially designed for NA Suitable for ✓
PKZM0/PKE, line terminal required for Type E/F applications

4)
Product Standards UL 508; CSA-C22.2 No.14; IEC60947-4-1;
CE marking
UL File No. E36332
UL CCN NLRV
CSA File No. 12528
CSA Class No. 3211-06
NA Certification UL Listed, CSA certified
Specially designed for NA Suitable for ✓
PKZM4/PKE, line terminal required for Type E/F applications

1

Three-phase commoning links

Finger- and back-of-hand-proof, short-circuit proof $U_p=690\text{ V}$, $I_p=128\text{ A}$

Circuit-breakers	Length	Unit width	Part no. Article no.	Price See price list	Std. pack	Information relevant for export to North America
Number	mm	mm				
For PKZM4 without side-mounted auxiliary contacts or voltage releases						
	2	110	55	B3.0/2-PKZ4 220220	1 off 	Product Standards UL 508; CSA-C22.2 No.14; IEC60947-4-1; CE marking E36332 UL File No. NLRV UL CCN 12528 CSA File No. 3211-06 CSA Class No. UL Listed, CSA certified NA Certification
	3	165	55	B3.0/3-PKZ4 220221	1 off 	
	4	220	55	B3.0/4-PKZ4 220222	1 off 	
For PKZM4 with one auxiliary contact or trip-indicating auxiliary contact each fitted on the right side						
	2	119	55 + 9	B3.1/2-PKZ4 220223	1 off 	
	3	183	55 + 9	B3.1/3-PKZ4 220224	1 off 	
	4	247	55 + 9	B3.1/4-PKZ4 220225	1 off 	
For PKZM4 with one auxiliary contact or trip-indicating auxiliary contact each fitted to right side, or one voltage release fitted to left side						
	2	128	55 + 18	B3.2/2-PKZ4 220226	1 off 	
	4	274	55 + 18	B3.2/4-PKZ4 220227	1 off 	

























































Shroud for unused terminals

Protection against direct contact.

To cover unused terminals on three-phase commoning link

Circuit-breakers	Length	Unit width	Part no. Article no.	Price See price list	Std. pack	Information relevant for export to North America
Number	mm	mm				
	–	–	H-B3-PKZ4 220228		10 off 	Product Standards UL 508; CSA-C22.2 No.14; IEC60947-4-1; CE marking UL File No. E36332 UL CCN NLRV CSA File No. 12528 CSA Class No. 3211-06 NA Certification UL Listed, CSA certified

A-PKZO, U-PKZO

Actuating voltage	Part no. Article no.	Price See price list	Std. pack	Part no. Article no.	Price See price list	Std. pack	Notes
Shunt release, undervoltage release							
AC							
Standard voltage							
24 V 50 Hz	A-PKZO(24V50Hz)¹⁾ 073181		2 off  	U-PKZO(24V50Hz)¹⁾ 073129		2 off  	
110 V 50 Hz	A-PKZO(110V50Hz)¹⁾ 073184		2 off  	U-PKZO(110V50Hz)¹⁾ 073132		2 off  	
220 V 50 Hz	A-PKZO(220V50Hz)¹⁾ 073186		2 off  	U-PKZO(220V50Hz)¹⁾ 073134		2 off  	
230 V 50 Hz	A-PKZO(230V50Hz)¹⁾ 073187		2 off  	U-PKZO(230V50Hz)¹⁾ 073135		2 off  	
240 V 50 Hz	A-PKZO(240V50Hz)¹⁾ 073188		2 off  	U-PKZO(240V50Hz)¹⁾ 073136		2 off  	
380 V 50 Hz	A-PKZO(380V50Hz)¹⁾ 073189		2 off  	U-PKZO(380V50Hz)¹⁾ 073137		2 off  	
400 V 50 Hz	A-PKZO(400V50Hz)¹⁾ 073190		2 off  	U-PKZO(400V50Hz)¹⁾ 073138		2 off  	
415 V 50 Hz	A-PKZO(415V50Hz)¹⁾ 073191		2 off  	U-PKZO(415V50Hz)¹⁾ 073139		2 off  	
120 V 60 Hz	A-PKZO(120V60Hz)¹⁾ 073195		2 off  	U-PKZO(120V60Hz)¹⁾ 073143		2 off  	
240 V 60 Hz	A-PKZO(240V60Hz)¹⁾ 073198		2 off  	U-PKZO(240V60Hz)¹⁾ 073146		2 off  	
440 V 60 Hz	A-PKZO(440V60Hz)¹⁾ 082164		2 off  	U-PKZO(440V60Hz)¹⁾ 082161		2 off  	
480 V 60 Hz	A-PKZO(480V60Hz)¹⁾ 073199		2 off  	U-PKZO(480V60Hz)¹⁾ 073147		2 off  	
Non-standard voltages not covered by above standard voltages							
...V 50 Hz (24 - 500 V)	A-PKZO(*V50Hz)¹⁾ 982165		2 off  	U-PKZO(*V50Hz) 982162			The part number for ordering consists of the basic part number and the actuating voltage. For non-standard voltages, specify the required actuating voltage within the indicated range (... - ... V). Minimum order quantity is 10 units
...V 60 Hz (24 - 600 V)	A-PKZO(*V60Hz)¹⁾ 982166		2 off  	U-PKZO(*V60Hz) 982163			
DC							
Standard voltage							
24 V DC	A-PKZO(24VDC)¹⁾ 073200		2 off  				
110 V DC	A-PKZO(110VDC)¹⁾ 073203		2 off  				

Information relevant for export to North America



1)
 Product Standards UL 508; CSA-C22.2 No.14; IEC60947-4-1; CE marking
 UL File No. E36332
 UL CCN NLRV
 CSA File No. 12528
 CSA Class No. 3211-05
 NA Certification UL Listed, CSA certified

1 Engineering

1- and 2-pole-connected PKZM0, PKZM4 with AC and DC



2-pole-connected PKZM0(1) and PKZM4 with CL-PKZ0

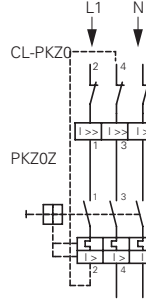

Protection of PVC-insulated cables against thermal overload on short-circuits

The table specifies which minimum conductor cross-sections are protected by motor-protective circuit-breaker PKZ(M) up to their rated conditional short-circuit current I_q .

Min. cross-section protected 380 – 415 V, 50 Hz, Cu mm ²	Device Part no.
4	PKZM0-0,16
2.5	PKZM0-6.3
1.5	PKZM0-10
1	PKZM0-12
0.75	PKZM0-16
	PKZM0-20
	PKZM0-25
	PKZM0-32
	PKZM4-16
	PKZM4-25
	PKZM4-32
	PKZM4-40
	PKZM4-50
	PKZM4-58
	PKZM4-63

PKZM0-...T tripping characteristics, PKZM01

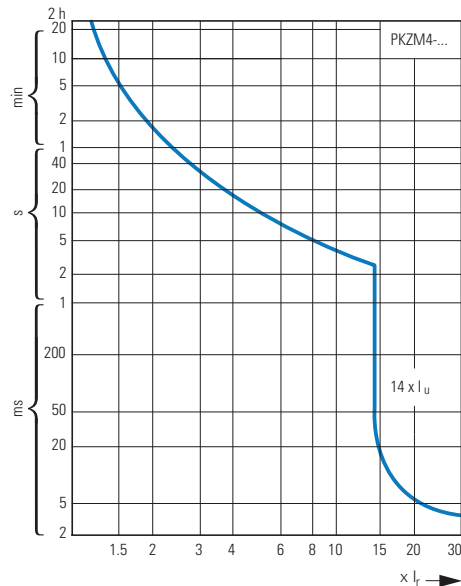
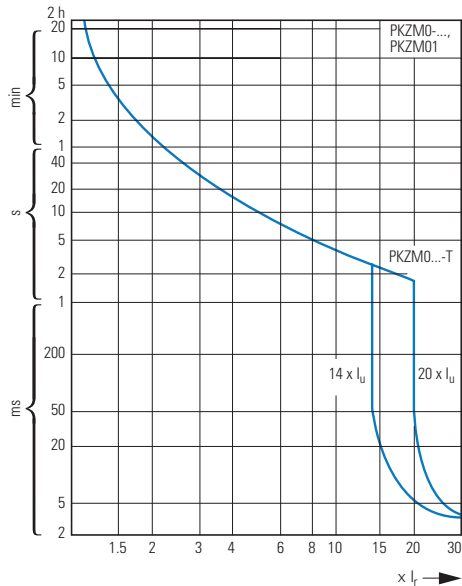

Tripping characteristic curves, wide-range circuit-breaker PKE

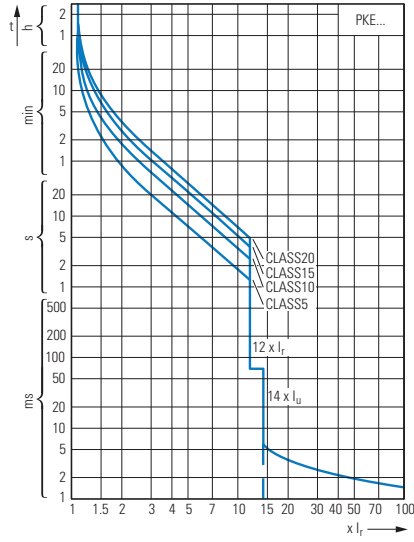

Let-through characteristics, motor-protective circuit-breaker, transformer-protective circuit-breakers, circuit-breaker for starter combinations

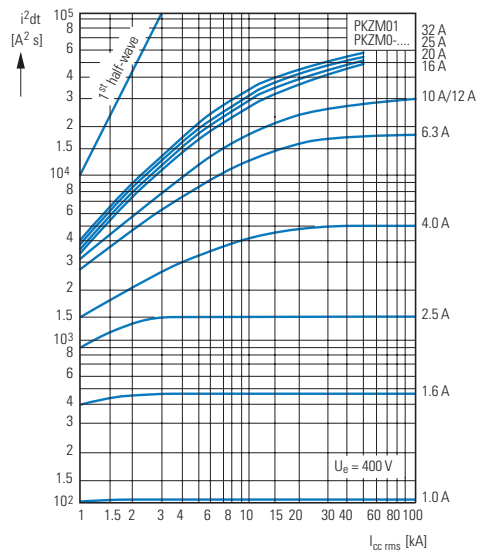
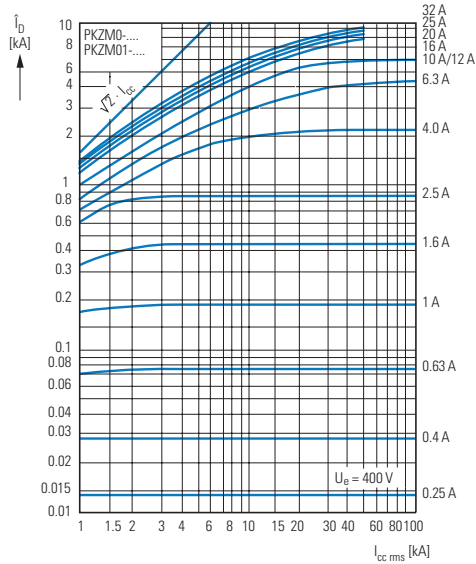

Motor-protective circuit-breaker let-through characteristics

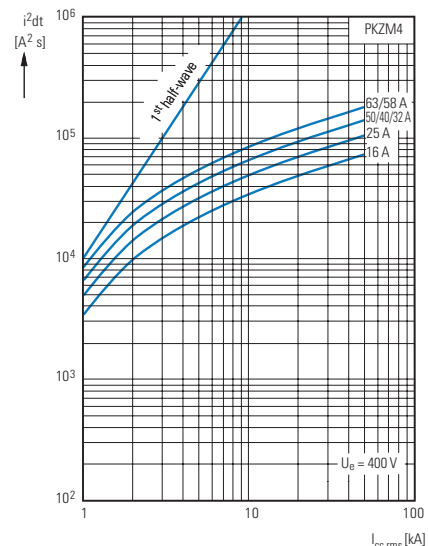
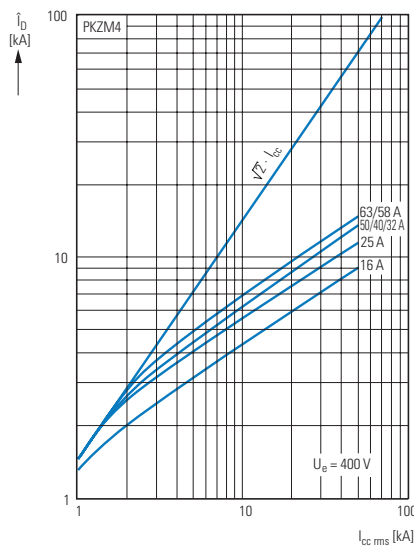

1.1

Motor-protective circuit-breakers PKZM01, PKZM0, PKZM4, PKE

Switching capacity

1 Circuit-breaker switching capacity from serial no. 04

Rated uninterrupted current I_u

Rated conditional short-circuit current I_q IEC/EN 60947-4-1

Rated ultimate short-circuit breaking capacity I_{cu}
 Rated breaking capacity I_{cs} } IEC/EN 60947-2

	230 V				400 V				440 V				500 V				690 V			
I_u	I_q	I_{cu}	I_{cs}	A ¹⁾	I_q	I_{cu}	I_{cs}	A ¹⁾	I_q	I_{cu}	I_{cs}	A ¹⁾	I_q	I_{cu}	I_{cs}	A ¹⁾	I_q	I_{cu}	I_{cs}	A ¹⁾
A	kA	kA	kA		kA	kA	kA		kA	kA	kA		kA	kA	kA		kA	kA	kA	

PKZM0, PKZM0...-T, PKM0 with type "1" and "2" coordination

0.16 - 1	150	150	150	N	150	150	150	N				N				N				N
1.6	150	150	150	N	150	150	150	N				N				N				N
2.5	150	150	150	N	150	150	150	N				N				N	5	5	5	50
4	150	150	150	N	150	150	150	N				N				N	3	3	3	50
6.3	150	150	150	N	150	150	150	N				N	42	42	11	50	3	3	2	50
10	150	150	150	N	150	150	150	N	42	42	12	50	42	42	11	50	3	3	2	50
12	50	50	13	50	50	50	13	50	15	15	12	50	15	15	8	50	3	3	2	50
16	50	50	13	50	50	50	13	50	15	15	12	50	15	15	8	50	3	3	2	50
20	50	50	13	50	50	50	13	50	10	10	13	50	6	6	3	50	3	3	1	50
25	50	50	13	50	50	50	13	50	10	10	13	50	6	6	3	50	3	3	1	50
32	50	50	13	50	50	50	13	50	10	10	13	50	6	6	3	50	3	3	1	50

PKZM0 (PKZM0...-T) + CL-PKZO

0.16 - 1				N				N				N				N				20	N
1.6				N				N				N				N				20	N
2.5				N				N				N				N	20	20	20	20	N
4				N				N				N				N	20	20	20	20	N
6.3				N				N				N			50	N	20	20	20	20	N
10				N				N				N			20	N	20	20	20	20	N
12				N				N				N			20	N	5	5	2.5	2.5	N
16				N				N				N			20	N	5	5	2.5	2.5	N
20				N				N				N	10	10	10	N	5	5	2.5	2.5	N
25				N				N				N	10	10	10	N	5	5	2.5	2.5	N
32				N				N				N	10	10	10	N	5	5	2.5	2.5	N

PKZM0 (PKZM0...-T) + 2 CL-PKZO

0.16 - 1				N				N				N				N				20	N
1.6				N				N				N				N				20	N
2.5				N				N				N				N	40	40	20	20	N
4				N				N				N				N	40	40	20	20	N
6.3				N				N				N			50	N	20	20	20	20	N
10				N				N				N			40	N	20	20	20	20	N
12				N				N				N			40	N	10	10	2.5	2.5	N
16				N				N				N			40	N	10	10	2.5	2.5	N
20				N				N				N	20	20	20	N	10	10	2.5	2.5	N
25				N				N				N	20	20	20	N	10	10	2.5	2.5	N
32				N				N				N	20	20	20	N	10	10	2.5	2.5	N

Notes No upstream protective device required, as it is the auto-protected range (100/150 kA)

¹⁾ Required back-up fuse if the short-circuit current exceeds the device's rated conditional short-circuit current ($I_{cc} > I_q$).

N Not necessary

Circuit-breaker switching capacity

Rated uninterrupted current I_u

Rated conditional short-circuit current I_q IEC/EN 60947-4-1

Rated maximum short-circuit breaking capacity I_{cu}
 Rated breaking capacity I_{cs} } IEC/EN 60947-2

I_u A	230 V				400 V				440 V ²⁾				500 V ²⁾				690 V ²⁾			
	I_q kA	I_{cu} kA	I_{cs} kA	A ¹⁾	I_q kA	I_{cu} kA	I_{cs} kA	A ¹⁾	I_q kA	I_{cu} kA	I_{cs} kA	A ¹⁾	I_q kA	I_{cu} kA	I_{cs} kA	A ¹⁾	I_q kA	I_{cu} kA	I_{cs} kA	A ¹⁾
PKZM01 with type "1" and "2" coordination																				
0.16 – 1	50	50	50	50	50	50	50	50	50	50	50	50	50	50	50	50	50	50	50	50
1.6	50	50	50	50	50	50	50	50	50	50	50	50	50	50	50	50	50	50	50	50
2.5	50	50	50	50	50	50	50	50	50	50	50	50	50	50	50	50	50	50	50	50
4	50	50	50	50	50	50	50	50	50	50	50	50	50	50	50	50	50	50	50	50
6.3	50	50	50	50	50	50	50	50	50	50	50	50	50	50	50	50	50	50	50	50
10	50	50	50	50	50	50	50	50	50	42	42	10	50							
12	50	50	10	50	50	50	10	50	15	15	10	50								
16	50	50	10	50	50	50	10	50	15	15	10	50								
20, 25	50	50	10	50	50	50	10	50	10	10	3	50								
PKZM4 with type "1" and "2" coordination																				
16	150	150	25	N	150	150	25	N	45	45	25	100	15	15	100	8	8	2.5	100	
25	150	150	25	N	150	150	25	N	45	45	25	100	15	15	100	8	8	2.5	100	
32	50	50	25	100	50	50	25	100	45	45	25	100	15	15	100	5	5	2.5	100	
40	50	50	25	100	50	50	25	100	45	45	25	100	15	15	100	5	5	2.5	100	
50	50	50	25	100	50	50	25	100	45	45	25	100	15	15	100	5	5	2.5	100	
58	50	50	25	160	50	50	25	160	45	45	25	160	15	15	160	5	5	2.5	160	
63	50	50	25	160	50	50	25	160	45	45	25	160	15	15	160	5	5	2.5	160	
PKE12...²⁾ with type of coordination „1" and																				
0.3 - 1.2	100			50	100			50	50			50	10			50	3			50
1 - 4	100			50	100			50	50			50	10			50	3			50
3 - 12	100			50	100			50	15			50	10			50	3			50
PKE32...²⁾ with type of coordination „1" and																				
3 - 12	100			50	100			50	15			50	6			50	3			50
8 - 32	100			50	100			50	25			50	6			50	3			50

Notes

■ No upstream protective device required, as it is the auto-protected range (150 kA)

N Not necessary

¹⁾ Fuse (A gG/gL) for increasing the switching capacity of the motor-protective circuit-breaker to 100 kA

²⁾ Please enquire for additional information regarding voltages >400 V and device combinations with CL-PKZO.

Motor-protective circuit-breaker internal resistances

	Impedance	Heat dissipation (3 pole at operating temperature)	Rated uninterrupted current I_u		Impedance	Heat dissipation (3 pole at operating temperature)	Rated uninterrupted current I_u
	Ω	W	A		Ω	W	A
PKZM0-0,16	78	6	0.16	PKZM4-16	0.029	22	16
PKZM0-0.25	32	6	0.25	PKZM4-25	0.012	22	25
PKZM0-0.4	13	6	0.4	PKZM4-32	0.007	22	32
PKZM0-0.63	5	6	0.63	PKZM4-40	0.005	22	40
PKZM0-1	2	6	1	PKZM4-50	0.003	22	50
PKZM0-1.6	0.8	6	1.6	PKZM4-58	0.002	22	58
PKZM0-2.5	0.32	6	2.5	PKZM4-63	0.002	22	65
PKZM0-4	0.13	6	4				
PKZM0-6.3	0.050	6	6.3				
PKZM0-10	0.020	6	10				
PKZM0-12	0.014	6	12				
PKZM0-16	0.008	6	16				
PKZM0-20	0.005	6	20				
PKZM0-25	0.003	6	25				
PKZM0-32	0.002	6	32				

1 Approvals for world markets

PKZM01, PKZM0, PKZM4

Rating data for approved types¹⁾
UL 508/CSA C 22.2 No. 14

	Maximum motor rating				Setting ranges		Maximum protective device to UL/CSA					
	Three-phase current				Overload releases	Short-circuit-releases	Group protection ²⁾					
	200 V	230 V	460 V	575 V			Up to max. short-circuit current	Maximum fuse rating		Maximum circuit breaker		
	HP	HP	HP	HP	A	A	600 V	with CL	with CL	with CL	with CL	
Motor-protective circuit-breakers PKZM01	"Manual Motor Starter with thermal and magnetic trip"											
PKZM01-0,16	3)				0.1 – 0.16	2.2	50	600		600		
PKZM01-0.25					0.16 – 0.25	3.4	50	600		600		
PKZM01-0.4					0.25 – 0.4	5.6	50	600		600		
PKZM01-0,63					0.4 – 0.63	8.8	50	600		600		
PKZM01-1					0.63 – 1	14	50	600		600		
PKZM01-1,6					1 – 1.6	22	50	600		600		
PKZM01-2.5	½	½	1	1½	1.6 – 2.5	35	50	600		600		
PKZM01-4	¾	¾	2	3	2.5 – 4	56	50	600		600		
PKZM01-6,3	1	1½	3	5	4 – 6.3	88	50	600		600		
PKZM01-10	3	3	7½	10	6.3 – 11	140	22	50	150	600	125	600
PKZM01-12	3	3	7½	10	9 – 12	168	18	50	150	600	125	600
PKZM01-16	3	5	10	10	10 – 16	224	10	50	150	600	125	600
PKZM01-20	5	-	-	15	16 – 20	280	10	18	150	600	125	600
PKZM01-25	-	7½	15	20	20 – 25	350	10	18	150	600	125	600
Motor-protective circuit-breakers PKZM01	"Manual Motor Starter with thermal and magnetic trip"											
PKZM0-0,16	3)				0.1 – 0.16	2.2	50	600		600		
PKZM0-0.25					0.16 – 0.25	3.4	50	600		600		
PKZM0-0.4					0.25 – 0.4	5.6	50	600		600		
PKZM0-0.63					0.4 – 0.63	8.8	50	600		600		
PKZM0-1					0.63 – 1	14	50	600		600		
PKZM0-1.6					1 – 1.6	22	50	600		600		
PKZM0-2.5	½	½	1	1½	1.6 – 2.5	35	50	600		600		
PKZM0-4	¾	¾	2	3	2.5 – 4	56	50	600		600		
PKZM0-6.3	1	1½	3	5	4 – 6.3	88	50	600		600		
PKZM0-10	3	3	7½	10	6.3 – 11	140	22	50	150	600	125	600
PKZM0-12	3	3	7½	10	9 – 12	168	18	50	150	600	125	600
PKZM0-16	3	5	10	10	10 – 16	224	10	50	150	600	125	600
PKZM0-20	5	-	-	15	16 – 20	280	10	18	150	600	125	600
PKZM0-25	-	7½	15	20	20 – 25	350	10	18	150	600	125	600
PKZM0-32	7½	10	20	25	24 – 32	448	10	18	150	600	125	600
Motor-protective circuit-breakers PKZM4												
PKZM4-16	3	5	10	15	10 – 16	224	50	600		600		
PKZM4-25	7½	7½	20	25	16 – 25	350	50	600		600		
PKZM4-32	10	10	25	30	25 – 34	448	50	600		600		
PKZM4-40	10	15	30	40	32 – 42	560	50	600		600		
PKZM4-50	10	15	30	40	40 – 52	700	10	600		600		
PKZM4-58	15	15	40	50	50 – 56	812	10	600		600		
PKZM4-63	15	15	40	50	52 – 58	882	10	600		600		

Notes

Service factor (SF)

Set value I_r on the current scale, depending on the load factor

$$SF = 1.15 \rightarrow I_r = 1 \times I_{n \text{ mot}}$$

$$SF = 1 \rightarrow I_r = 0.9 \times I_{n \text{ mot}}$$

¹⁾ Devices for world markets IEC \triangle UL/CSA²⁾ Caution: Changed requirements for group protection³⁾ Calculate motor output in this range according to rated operational current. Specified values as per NEC Table 430 – 150

PKZM

Rating data for approved types¹⁾
UL 508/CSA C 22.2 No. 14

		For use with	Pilot Duty	General Use	
Accessories					
Standard auxiliary contacts	NHI11-PKZO	PKZM0(-T) PKZM4	A 600, Q 300	5 A – 600 V AC 1 A – 250 V DC	–
	NHI12-PKZO				
	NHI21-PKZO				
	NHI2-11S-PKZO				
	NHI-E-11-PKZO				
Early-make auxiliary contacts	NHI-E-10-PKZO		E150	0.5 A – 250 V AC	–
	VHI20-PKZO	PKZM0(-T)	E150	0.5 A – 250 V AC	–
Trip indicators	VHI20-PKZO1	PKZM01	E150	0.5 A – 250 V AC	–
	AGM2-10-PKZO	PKZM0(-T)	A 600, Q 300	5 A – 600 V AC 1 A – 250 V DC	–
AGM2-01-PKZO	PKZM4				
Shunt release	A-PKZO(...)	PKZM0(-T) PKZM4	–	–	Actuating voltages and ordering information → Products for the German market
	U-PKZO(...)				
Auxiliary contact for contact module	HI11-S/EZ-PKZO	PKZM0	A 600, Q 300	5 A – 600 V AC 1 A – 250 V DC	–

Notes

¹⁾ Devices for world markets IEC Δ UL/CSA

PKZM

Motor-protective circuit-breakers PKZM0(4) used as "Manual self-protected Motor Starters" – UL 508 Type E

Maximum motor output AC				Setting ranges		Interrupting Capacity = Short Circuit Current (SCCR)			Components			
200 V	230 V	460 V	575 V	Overload releases	Short-circuit releases	240 V	480Y/ 277 V ²⁾	600Y/ 347 V ²⁾	Motor Protector	Accessories		
208 V	240 V	480 V	600 V	[A]	[A]	[kA]	[kA]	[kA]	Part no.	Part no.		
¹⁾				0.1 – 0.16	2.2	65	65	50	PKZM0-0.16	BK25/3-PKZO-E		
				0.16 – 0.25	3.4	65	65	50	PKZM0-0.25	BK25/3-PKZO-E		
				0.25 – 0.4	5.6	65	65	50	PKZM0-0.4	BK25/3-PKZO-E		
				0.4 – 0.63	8.8	65	65	50	PKZM0-0.63	BK25/3-PKZO-E		
				0.63 – 1	14	65	65	50	PKZM0-1	BK25/3-PKZO-E		
				¾	¾	1 – 1.6	22	65	65	50	PKZM0-1.6	BK25/3-PKZO-E
½	½	1	1½	1.6 – 2,5	35	65	65	50	PKZM0-2.5	BK25/3-PKZO-E		
¾	¾	2	3	2.5 – 4	56	65	65	50	PKZM0-4	BK25/3-PKZO-E		
1	1½	3	5	4 – 6.3	88	65	65	50	PKZM0-6.3	BK25/3-PKZO-E		
3	3	7½	10	6.3 – 11	140	65	65	50	PKZM0-10	BK25/3-PKZO-E		
3	3	7½	–	9 – 12	168	65	65	–	PKZM0-12	BK25/3-PKZO-E		
3	5	10	–	10 – 16	224	42	42	–	PKZM0-16	BK25/3-PKZO-E		
5	–	–	–	16 – 20	280	18	18	–	PKZM0-20	BK25/3-PKZO-E		
–	7½	15	–	20 – 25	350	18	18	–	PKZM0-25	BK25/3-PKZO-E		
7½	10	20	–	24 – 32	448	18	18	–	PKZM0-32	BK25/3-PKZO-E		
3	5	10	10	10 – 16	224	65	65	25	PKZM4-16	BK50/3-PKZ4-E		
5	7½	15	20	16 – 27	350	65	65	25	PKZM4-25	BK50/3-PKZ4-E		
7½	10	20	30	24 – 34	448	65	65	25	PKZM4-32	BK50/3-PKZ4-E		
10	–	30	30	32 – 40	560	65	65	25	PKZM4-40	BK50/3-PKZ4-E		
–	15	30	–	40 – 52	700	65	65	–	PKZM4-50	BK50/3-PKZ4-E		
–	–	40	–	50 – 56	812	65	65	–	PKZM4-58	BK50/3-PKZ4-E		
–	–	40	–	52 – 58	882	65	–	–	PKZM4-63	BK50/3-PKZ4-E		

Notes

¹⁾ Calculate motor power in this range according to the rated current. Stated values to NEC Table 430 -150

²⁾ Suitable for networks with grounded star-point

1 Technical data

PKZM, PKE

		PKZM01...	PKZM0-... ¹⁾
General			
Standards		IEC/EN 60947, VDE 0660, UL 508, CSA C 22.2 No. 14	
Climatic proofing		Damp heat, constant, to IEC 60068-2-78 Damp heat, cyclic, to IEC 60068-2-30	
Ambient temperature	Storage	°C	-25...80
	Open	°C	-25...55
	Encapsulated	°C	-25...40
Built-in position			
Direction of incoming supply		Any	Any
Degree of protection	Device	IP20	IP20
	Terminals	IP00	IP00
Contact protection to EN 50274		Finger- and back-of-hand proof	
Shock resistance, half-sinusoidal shock, 10 ms to IEC 60068-2-27		g	25
Installation altitude		m	2000
Terminal capacity, screw terminals	Solid	mm ²	1 × (1 - 6) 2 × (1 - 6)
		mm ²	1 × (1 - 6) 2 × (1 - 6)
	Flexible with ferrule to DIN 46228	mm ²	1 × (1 - 6) 2 × (1 - 6)
		AWG	18 - 10
Terminal capacity, spring-loaded terminals	Solid	mm ²	–
		mm ²	1 × (1...2.5) 2 × (1...2.5)
	Flexible with ferrule to DIN 46228	mm ²	–
		AWG	–
Terminal screw tightening torque	Main conductors	Nm	1.7
	Auxiliary conductors	Nm	1
Main contacts			
Rated impulse withstand voltage	U_{imp}	V AC	6000
Overvoltage category/pollution degree			III/3
Rated operational voltage	U_e	V AC	690
Rated uninterrupted current = rated operational current	$I_u = I_e$	A	16 or current setting of the overcurrent release
Rated frequency		Hz	40 - 60
Heat dissipation (3 pole at operating temperature)		W	6
Lifespan, mechanical	Operations	x 10 ⁶	0.05
Lifespan, electrical (AC-3 at 400 V)	Operations	x 10 ⁶	0.05
Maximum operating frequency	Operations/h	Ops/h	25
Short-circuit rating			
AC			→ Page 33
DC		kA	60
Motor switching capacity			
AC-3 up to 690 V	A		16
DC-5 (up to 250 V)	A		16 (3 contacts in series)
Trip blocks			
Temperature compensation			
To IEC/EN 60947, VDE 0660	°C		-5...40
Operating range	°C		-25...55
Temperature compensation residual error for T > 40 °C	%/K		≅ 0.25
Setting range of overload releases	x I_u		0.6 - 1
Short-circuit releases tolerance	%		± 20
Phase-failure sensitivity			IEC/EN 60947-4-1, VDE 0660 Part 102
			IEC/EN 60947-4-1, VDE 0660 Part 102

Notes

¹⁾ Tested according to IEC/EN 60947-1 (isolating characteristics) and IEC/EN 60947-2

PKZM0-...-T	PKZM4	PKE
IEC/EN 60947, VDE 0660, UL 508, CSA C 22.2 No. 14		
Damp heat, constant, to IEC 60068-2-78		
Damp heat, cyclic, to IEC 60068-2-30		
-25...80	-25...70	-25...80
-25...55	-25...55	-25...55
-25...40	-25...40	-25...40
Any	Any	Any
IP20	IP20	IP20
IP00	IP00	IP00
Finger- and back-of-hand proof		
25	15	25
max. 2000	max. 2000	max. 2000
1 × (1 - 6)	1 × (1 - 50)	1 × (1 - 6)
2 × (1 - 6)	2 × (1 - 35)	2 × (1 - 6)
1 × (1 - 6)	1 × (1 - 35)	1 × (1 - 6)
2 × (1 - 6)	2 × (1 - 35)	2 × (1 - 6)
18 - 10	14 - 2	18 - 10
–	–	1 × (1...2.5) 2 × (1...2.5)
–	–	1 × (1...2.5) 2 × (1...2.5)
–	–	18...14
1.7	3.3	1.7
1	1	1
6000	6000	6000
III/3	III/3	III/3
690	690	690
25 or current setting of the over-current release	65 Open 63 enclosed	32 A or set current of the overcurrent release
40 - 60	40 - 60	40 - 60
6	22	6
0.1	0.03	0.05
0.1	0.03	0.05
40	40	60
→ Page 32	→ Page 33	→ Page 33
60 (up to PKZM0-16) 40 (PKZM0-20 to PKZM0-32)	60	–
25	65	32
25 (3 contacts in series)	63 (3 contacts in series)	–
–5...40	–5...40	–5...40
–25...55	–25...55	–25...55
≅0.25	≅0.25	
0.6 - 1	0.6 - 1	0.25 - 1
± 20	± 20	± 20
IEC/EN 60947-1-1, VDE 0660 Part 102	IEC/EN 60947-4-1, VDE 0660 Part 102	Yes

1 NHI...PKZ, AGM, U-PKZ, A-PKZ

			NHI...PKZ0	NHI-E...PKZ0	VHI...PKZ0	AGM	
Auxiliary contacts							
Rated impulse withstand voltage	U_{imp}	V AC	6000	4000	4000	6000	
Overvoltage category/pollution degree			III/3	III/3	III/3	III/3	
Rated operating voltage							
	U_e	V AC	500	440	440	500	
	U_e	V DC	250	250	250	250	
Safe isolation according to EN 61140							
		V AC	690	690	690	690	
Rated operational current							
AC-15							
	220 - 240 V	I_e	A	3.5	1	1	3.5
	380 - 415 V	I_e	A	2	–	–	2
	440 - 500 V	I_e	A	1	–	–	1
DC-13 L/R \leq 100 ms							
	24 V	I_e	A	2	2	2	2
	60 V	I_e	A	1.5	–	–	1.5
	110 V	I_e	A	1	–	–	1
	220 V	I_e	A	0.25	–	–	0.25
Durability							
	Lifespan, mechanical	Operations	$\times 10^6$	> 0.1	> 0.1	> 0.1	> 0.01
	Lifespan, electrical	Operations	$\times 10^6$	> 0.05	> 0.1	> 0.1	> 0.05
	Control circuit reliability (at $U_e = 24$ V DC, $U_{min} = 17$ V, $I_{min} = 5.4$ mA)	Fault probability	λ	< 10^{-8} < 1 failure in 1×10^8 operations			
	Interlocked opposing contacts			Yes	–	–	–
Short-circuit rating without welding							
	Fuseless			FAZ-B4/1-HI	–	–	FAZ-B4/1-HI
	Fuse	A gG/gL		10	10	10	10
Terminal capacity							
	Solid or flexible conductor with ferrule		mm ²	0.75 - 2.5	0.75 - 1.5	0.75 - 1.5	0.75 - 2.5
	Solid or stranded		AWG	18 - 14	18 - 16	18 - 16	18 - 14

NHI...PKZ, AGM, U-PKZ, A-PKZ

			Undervoltage release U-PKZ...	Shunt release A-PKZ...	
General					
Terminal capacity					
	Solid or flexible conductor with ferrule	mm ²	1 \times (0.75 - 2.5) 2 \times (0.75 - 2.5)	1 \times (0.75 - 2.5) 2 \times (0.75 - 2.5)	
	Solid or stranded	AWG	1 \times (18 - 14) 2 \times (18 - 14)	1 \times (18 - 14) 2 \times (18 - 14)	
Main contacts					
	Rated operating voltage	U_e	V AC	42 - 480	42 - 480
	Rated operating voltage	U_e	V DC	24 - 250	24 - 250
Pick-up-/drop-out voltage					
	Pick-up voltage	$x U_s$		0.85 - 1.1	
	Drop-out voltage	$x U_s$		0.7 - 0.35	
Operating range					
	AC voltage		$x U_s$		0.7...1.1
	DC voltage (intermittent operation 5 s)		$x U_s$		0.7...1.1
Power consumption					
AC voltage					
	AC pick-up rating	Pick-up	VA	5	5
	AC consumption when closed	Holding	VA	3	3
DC voltage					
	DC pick-up rating	Pick-up	W	–	3
	DC consumption when closed	Holding	W	–	3

Dimensions

Motor-protective circuit-breaker

PKZM01...

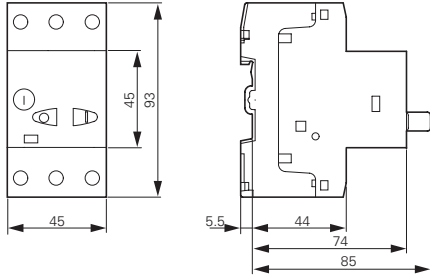

Motor-protective circuit-breaker Transformer-protective circuit-breakers Motor-protective circuit-breaker with standard auxiliary contacts

PKZM0...(+NHI-E...-PKZ0)
PKZM0...-T(+NHI-E...-PKZ0)

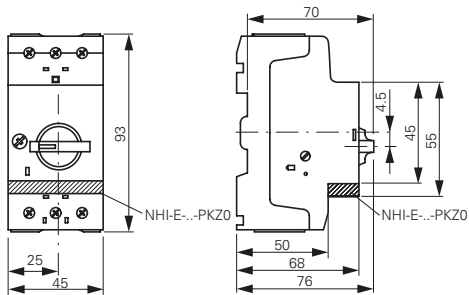

Motor-protective circuit-breakers with lockable rotary handles

PKZM0...+AK-PKZ0

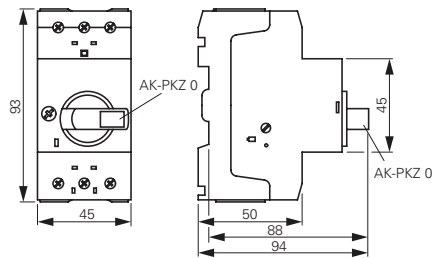

Current limiters

CL-PKZ...

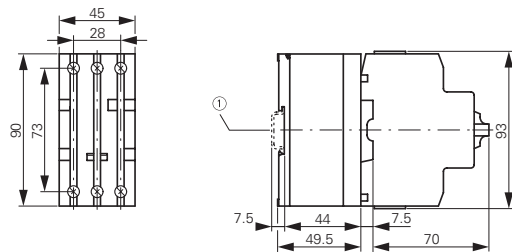

① Top-hat rail IEC/EN 60715

Motor-protective circuit-breakers with early-make auxiliary contacts

PKZM0...+VHI...-PKZ0

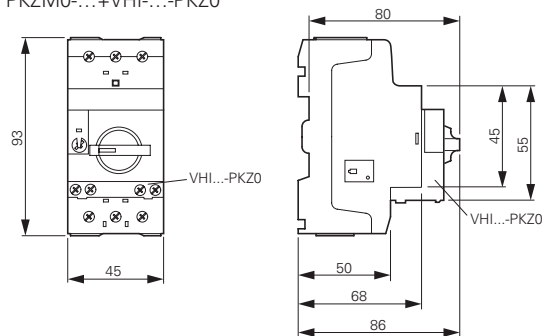

Standard auxiliary contacts

NHI...-PKZ0

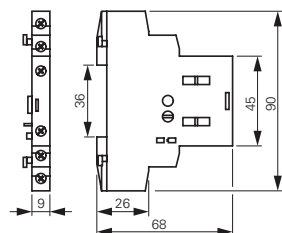

Trip indicators

AGM2...-PKZ0

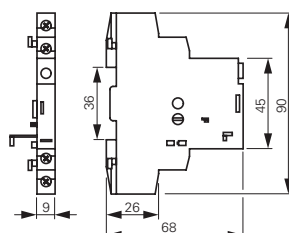

Shunt release Undervoltage release

A-PKZ0...

U-PKZ0...

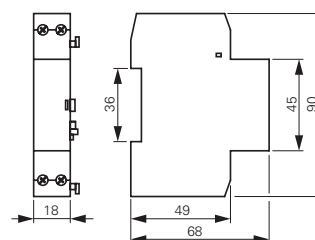

1.1

Motor-protective circuit-breakers PKZM01, PKZM0, PKZM4, PKE

Busbar adapters

1

BBA0-25
BBA0-25/2TS
BBA0/2TS-L
BBA0-32
BBA0-32/2TS-C
BBA0C-16

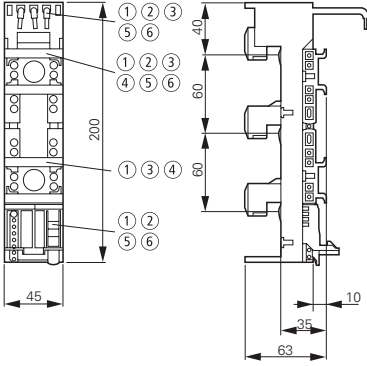

- ① BBA0-32/2TS-C
- ② BBA0-25/2TS
- ③ BBA0C-16
- ④ BBA0/2TS-L
- ⑤ BBA0-25
- ⑥ BBA0-32

BBA2-63
BBA2-63/2TS

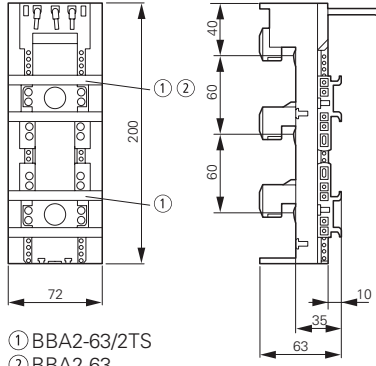

- ① BBA2-63/2TS
- ② BBA2-63

BBA4/2TS-L
BBA4L-63

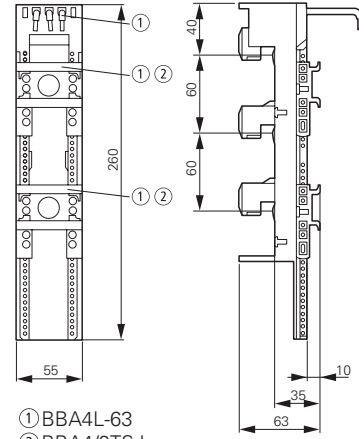

- ① BBA4L-63
- ② BBA4/2TS-L

BBA4-63

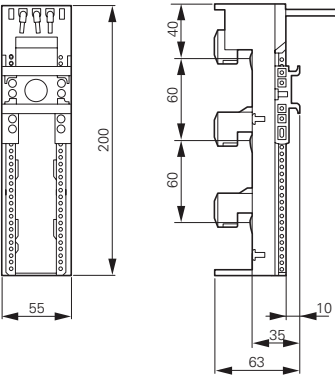

BBA2-80/2TS-S

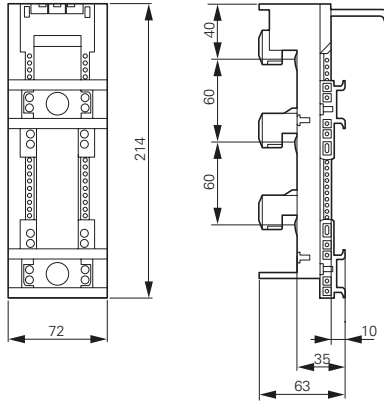

BBA2L-63

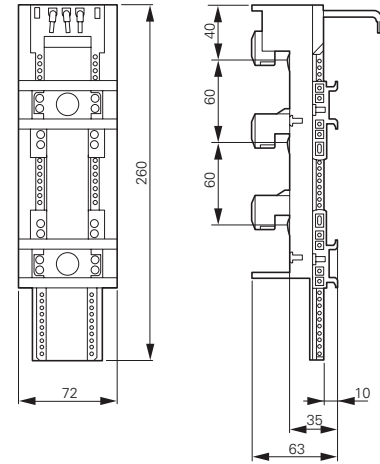

BBA0L-25
BBA0L-32

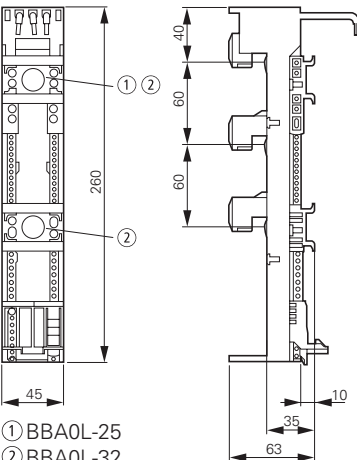

- ① BBA0L-25
- ② BBA0L-32

BBA0K-32

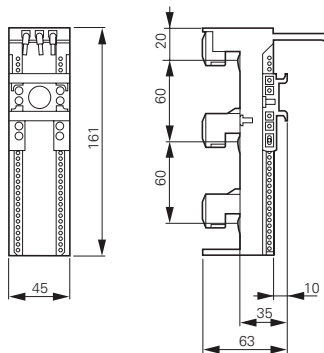

PKZM0-XC45L
PKZM0-XC45L-2

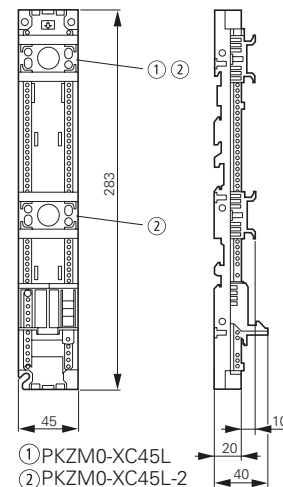

- ① PKZM0-XC45L
- ② PKZM0-XC45L-2

Insulated enclosures for surface mounting

CI-PKZ0-M

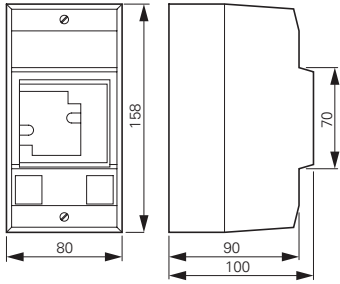

CI-PKZ10G...M

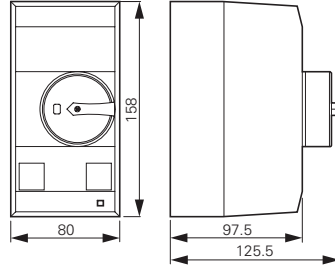

CI-PKZ0...M
+ SVB-PKZ0-CI

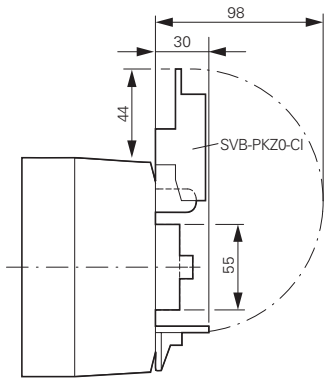

Drilling dimensions
CI-PKZ0...M

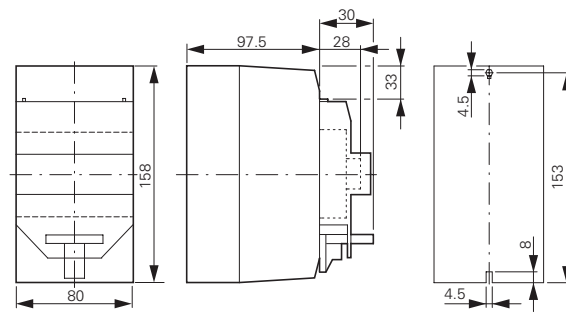

CI-K2-PKZ0

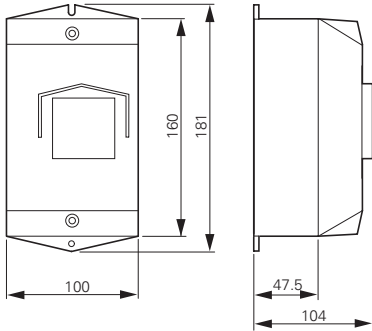

CI-K2-PKZ0G(R)(V)

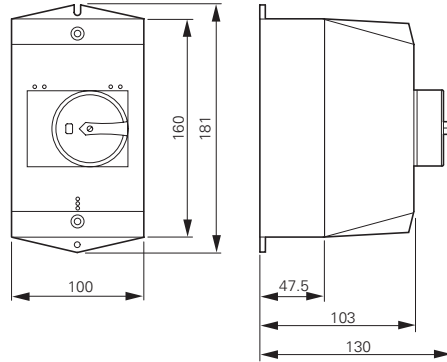

CI-K2-PKZ0-G(R)(V)
+ SVB-PKZ0-CI

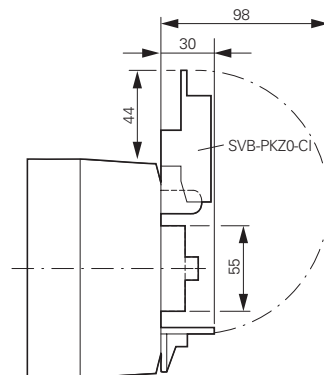

Drilling dimensions
CI-K2-PKZ0...

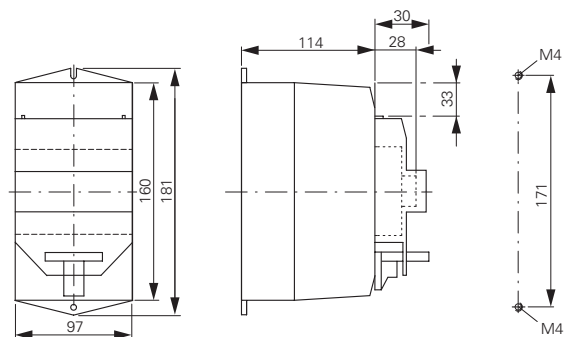

1.1

Motor-protective circuit-breakers PKZM01, PKZM0, PKZM4, PKE

Accessories

1 Door coupling handles

PKZ0-X(R)H...

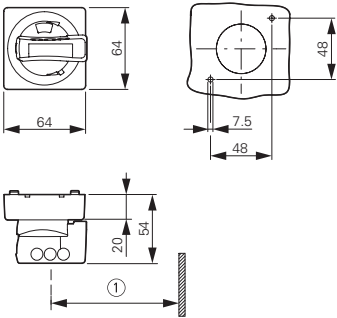

Mounting depth: 100 to 240 mm
from the top edge of the top-hat rail
to the front edge of the cabinet
door/cover
Distance between switch axis and
cover hinge: at least 100 mm

① At least 100 mm from cover hinge

Insulated enclosures for flush mounting

E-PKZ0 E-PKZ0-G...

Mounting aperture E-PKZ0...

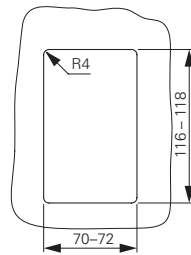
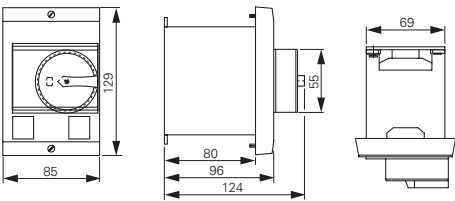

E-PKZ0-G... + SVB-PKZ0-E

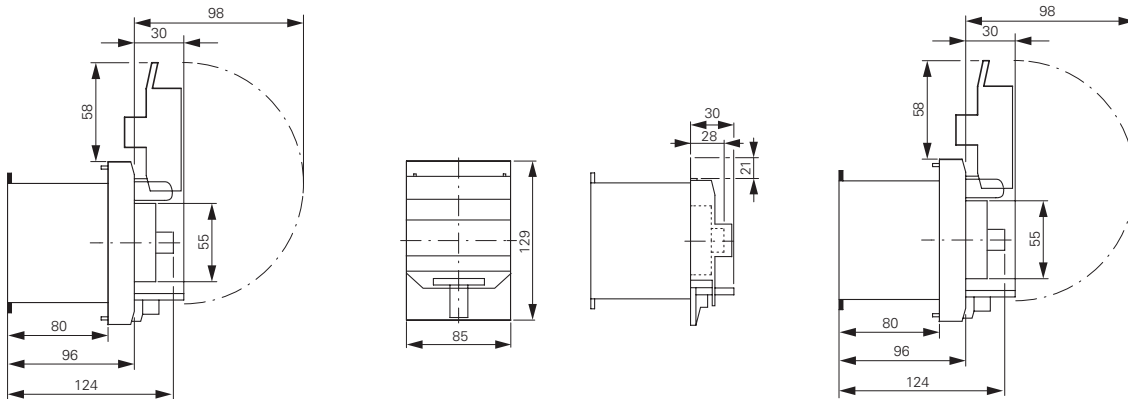

Insulated enclosures for surface mounting

CI23E...

Mounting plates

M3-CI23

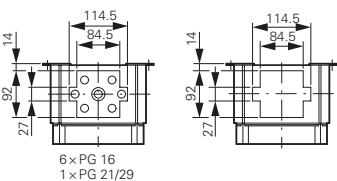
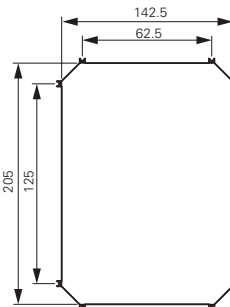
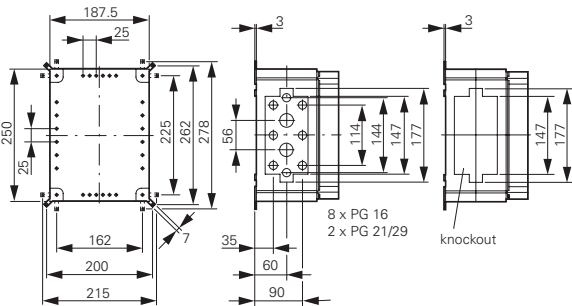

Insulated enclosures for surface mounting

CI-PKZ01
CI-PKZ01-G

CI-PKZ01-PVT
CI-PKZ01-PVS

CI-PKZ01-SVB
CI-PKZ01-SVB-V

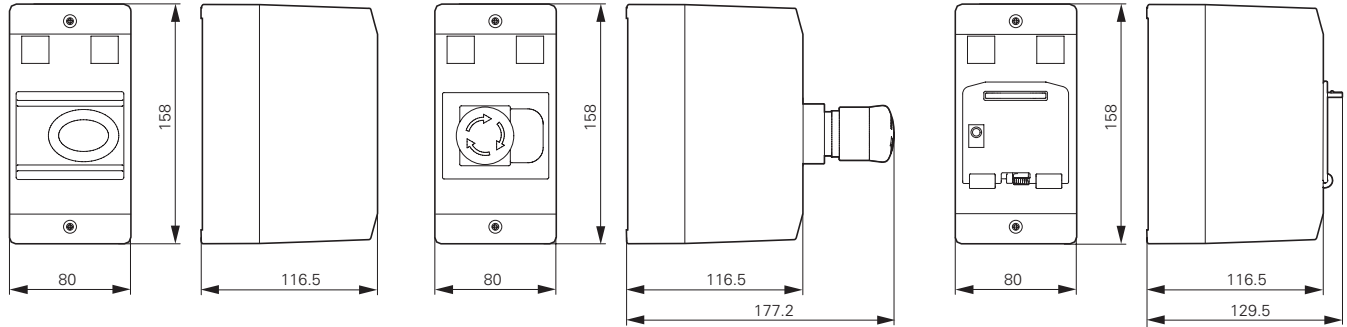

Insulated enclosures for flush mounting

E-PKZ01
E-PKZ01-G

E-PKZ01-PVT
E-PKZ01-PVS

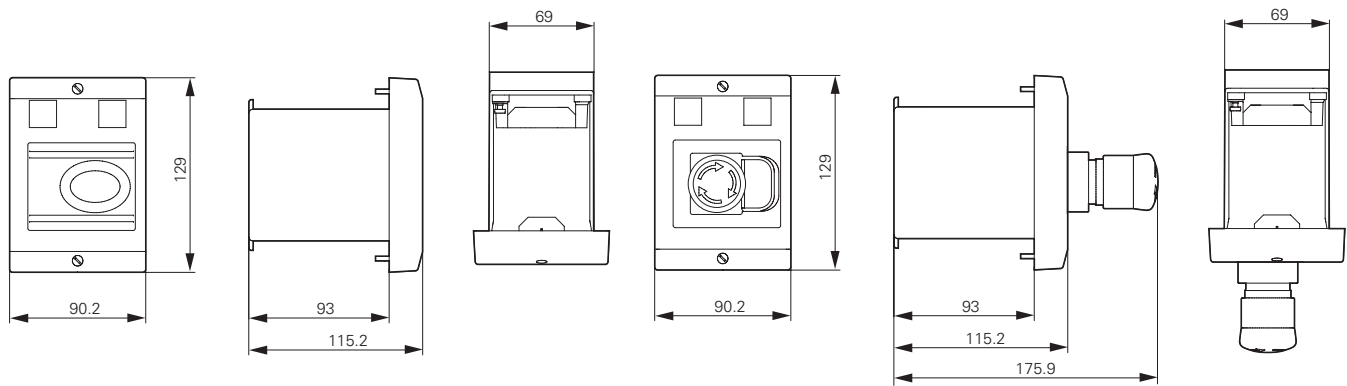

E-PKZ01-SVB
E-PKZ01-SVB-V

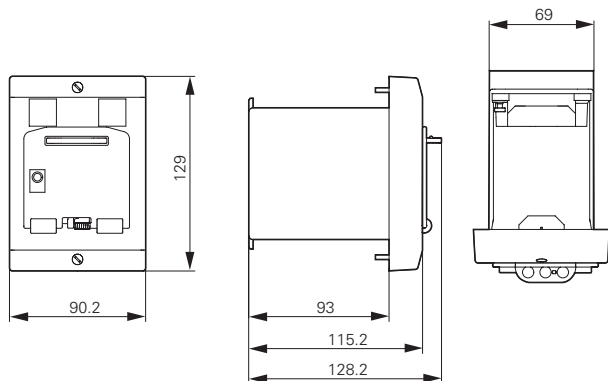

1.1

Motor-protective circuit-breakers PKZM01, PKZM0, PKZM4, PKE

Accessories

1 Motor-protective circuit-breaker

PKZM4-...

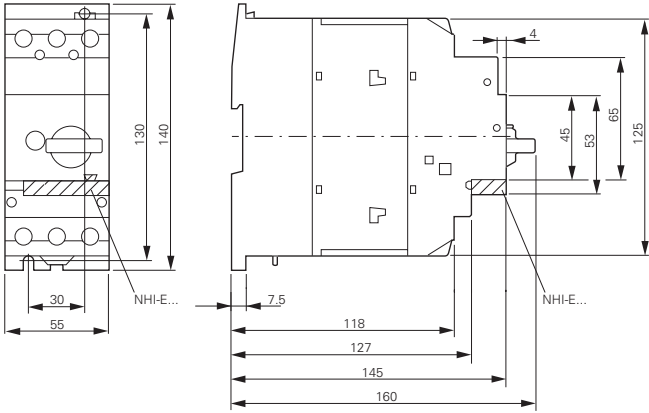

Standard auxiliary contacts

NHI...-PKZ...

NHI...-PKZ0

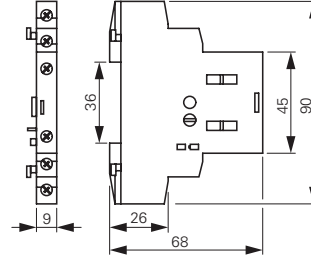

Motor-protective circuit-breakers with lockable cover

PKZM4-... +AK-PKZ0

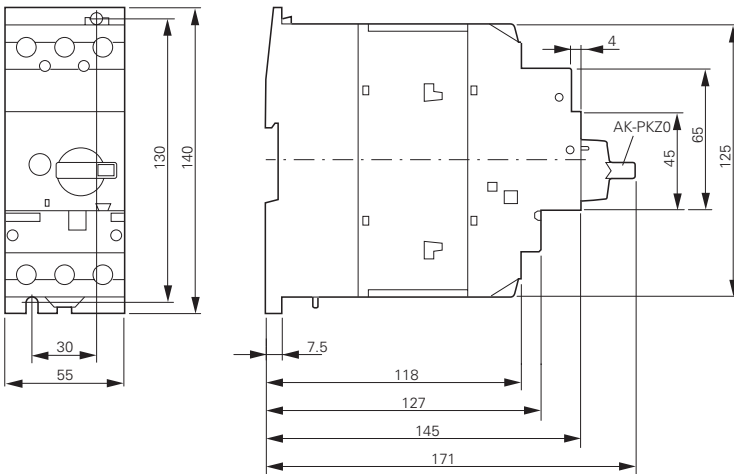

Trip indicators

AGM2...-PKZ...

AGM2...-PKZ0

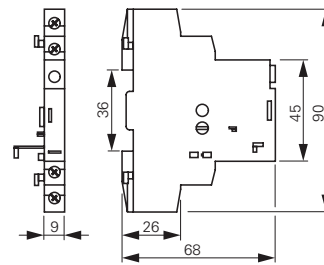

PKE Motor-protective circuit-breakers

PKE12, PKE32

PKE65

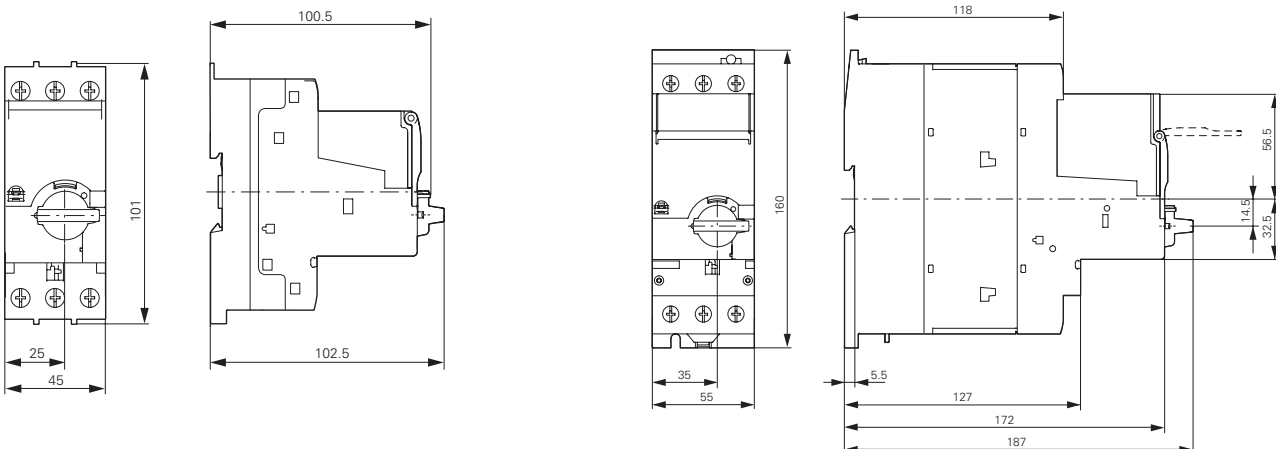

Three-phase commoning links

B3.0/4-PKZ4

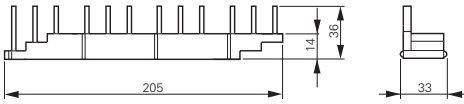

B3.0/3-PKZ4

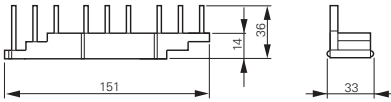

B3.0/2-PKZ4

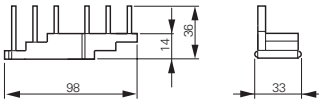

B3.1/4-PKZ4

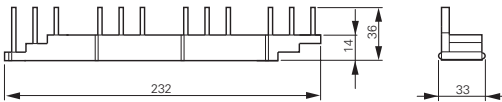

B3.2/4-PKZ4

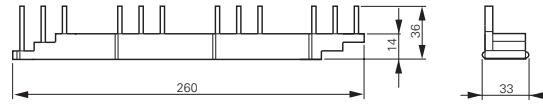

B3.2/2-PKZ4

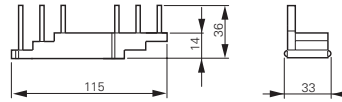

B3.0/3-PKZ4

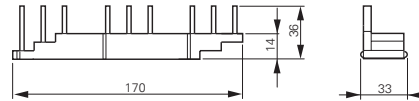

B3.1/2-PKZ4

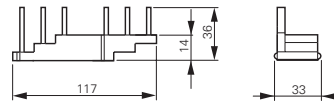

Three-phase commoning links

B3.0/4-PKZ0

B3.0/2-PKZ0

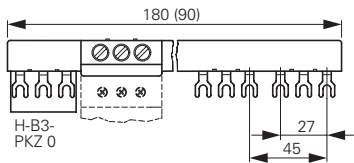

Three-phase commoning links

B3.1/5-PKZ0

B3.1/3-PKZ0

B3.1/4-PKZ0

B3.1/2-PKZ0

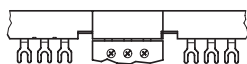
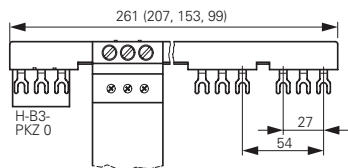

Motor plug DILM12-XMCP/T

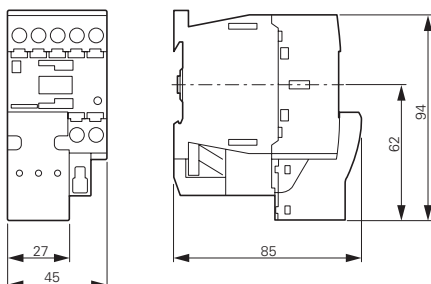

Three-phase commoning links

B3.2/4-PKZ0

B3.2/2-PKZ0

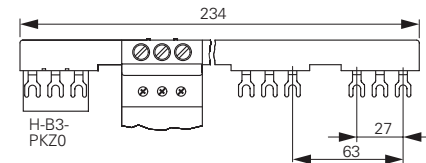

Incoming terminals

BK25/3-PKZ0

Overlapping mounting to extend the three-phase commoning link

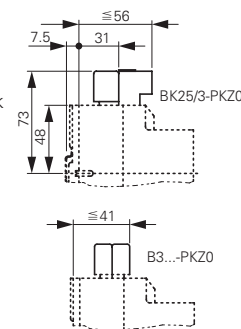

1.1

Motor-protective circuit-breakers PKZM01, PKZM0, PKZM4, PKE

Accessories

1 Insulated enclosures for surface mounting

CI-K4-PKZ4-G(R)
+SVB-PKZ4-CI

CI-K4-PKZ4-G

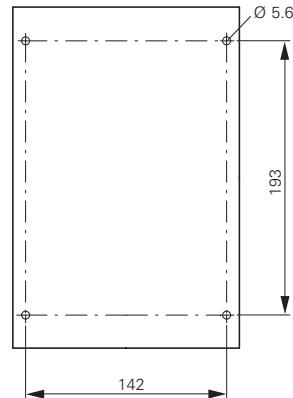
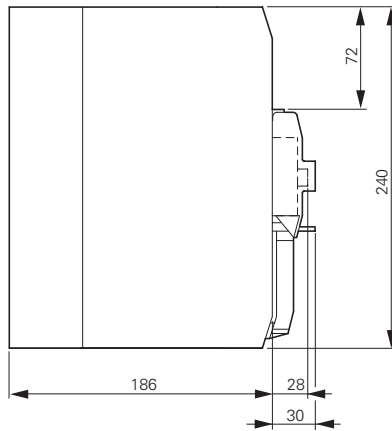
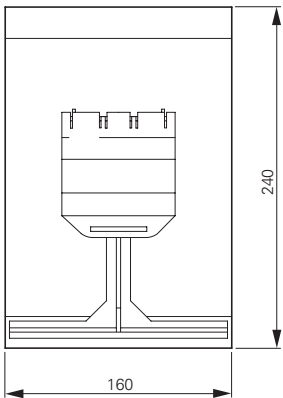
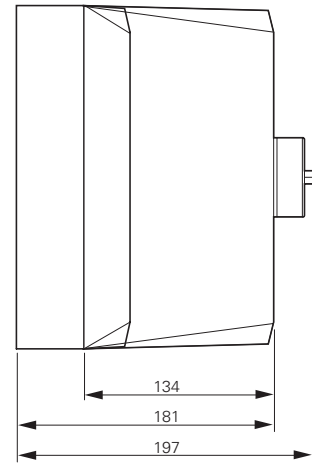
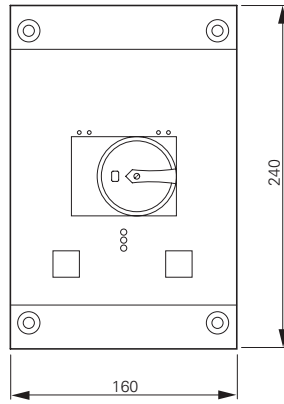
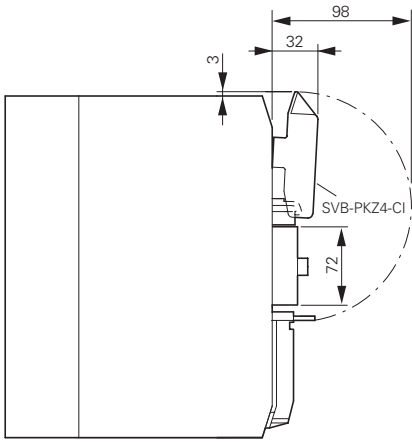

Drilling dimensions
CI-K4-PKZ4-G(R)

Motor protection circuit breakers PKZMC



- Switches motors up to 32A
- Short-circuit protection capacity up to 65kA
- Common accessories with PKZM0 and PKZM4

Contents

Description

Page

Motor protection circuit breakers PKZMC	
System overview	48
Basic devices	49
Standard auxiliary contacts	50
Trip-indicating auxiliary contact	52
Early-make auxiliary contact	52
Current limiters	52
Shunt release	52
Undervoltage release	52
Insulated enclosure	54
Other accessories	56
Actuating voltage	59
Tripping characteristic curves	60
Technical data	61
Dimensions	66

1 High price-performance-ratio motor protection solutions via PKZMC

With PKZMC, everyone can access to modern technology for motor protection

Can be combined with contactors to serve as manually operated motor starter.

Compact and modular design, easy operating, high protection rate.

Common accessories with PKZM0 motor starters.

Comply to all of major standards.

Safety first

PKZMC series comply with all technical standards for main switches.

PKZMC can protect your machine equipment powered by small rating motor, and can manually switch on your equipment.

Emergency stop and locking functions come with PKZMC as standard.

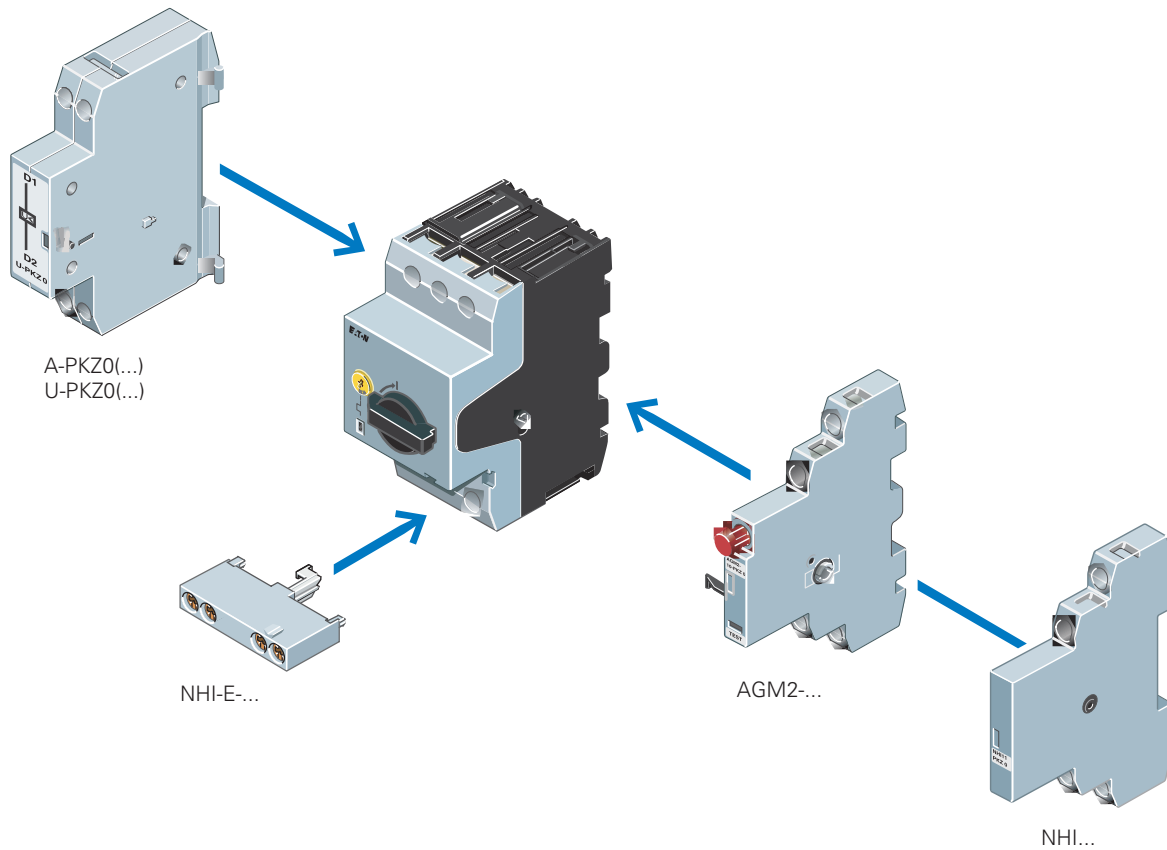

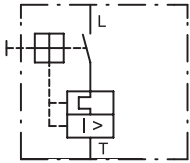
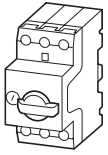

Basic devices

Max. motor rating AC-3 380/400V P kW	Rated uninterrupted current I_u A	Overload release Setting range I_r A	Rated ultimate short-circuit breaking capacity I_{cu}			Part no. Article no.
			220V kA	380/400V kA	440V kA	
–	0.16	0.1 – 0.16	65	65	65	PKZMC-0,16 225358
0.06	0.25	0.16 – 0.25	65	65	65	PKZMC-0,25 225364
0.09	0.4	0.25 – 0.4	65	65	65	PKZMC-0,4 225370
0.12	0.63	0.4 – 0.63	65	65	65	PKZMC-0,63 225376
0.25	1	0.63 – 1	65	65	65	PKZMC-1 225383
0.55	1.6	1 – 1.6	65	65	65	PKZMC-1,6 225387
0.75	2.5	1.6 – 2.5	65	65	65	PKZMC-2,5 225389
1.5	4	2.5 – 4	65	65	65	PKZMC-4 225390
2.2	6.3	4 – 6.3	65	16	6	PKZMC-6,3 225391
4	10	6.3 – 10	16	16	6	PKZMC-10 225394
7.5	16	10 – 16	16	16	6	PKZMC-16 225395
9	20	16 – 20	12	12	6	PKZMC-20 225396
12.5	25	20 – 25	12	12	6	PKZMC-25 225397
15	32	25 – 32	12	12	6	PKZMC-32 112112

1.2

Motor protection circuit breakers PKZMC

Standard auxiliary contacts

1

Standard auxiliary contacts

Contact Circuit diagrams Contact sequence For use with

N/O = normally open contact
N/C = normally closed contact

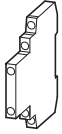

1 N/O 1 N/C

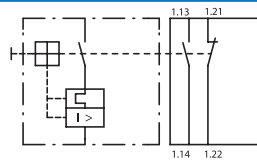
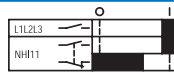

Screw terminals

PKZMC

1 N/O 2 N/C

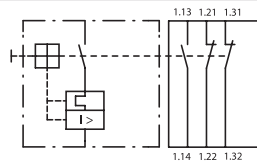
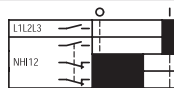

Screw terminals

PKZMC

2 N/O 1 N/C

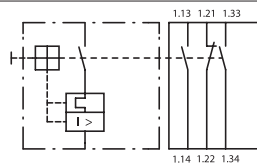
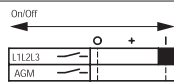

Screw terminals

PKZMC



1 N/O 1 N/C

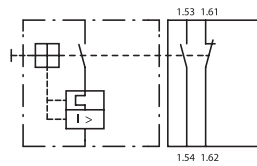

Screw terminals

PKZMC

1 N/O -

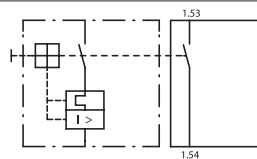

Screw terminals

PKZMC

Auxiliary contacts, undervoltage releases

Contact Circuit diagrams Contact sequence For use with

N/O = normally open contact
N/C = normally closed contact

Trip-indicating auxiliary contact

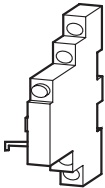

2 × 1 N/O

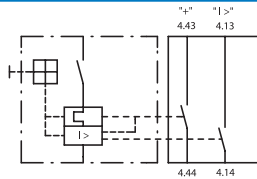
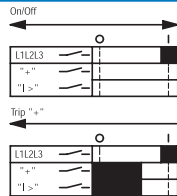

PKZMC

2 × 1 N/C

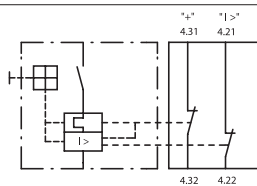
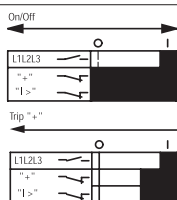

PKZMC

Early-make auxiliary contact



2 N/O

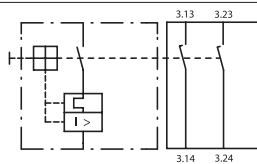

PKZMC

Shunt release

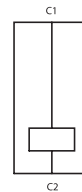
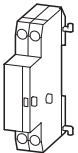

PKZMC

Undervoltage release

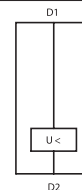
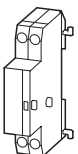

PKZMC

Current limiters

For increasing switching capacity of motor-protective circuit-breakers without auto-protection motor-protective circuit breakers PKZM0-16,-20,-25,-32 reach 150kA/440V

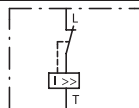

PKZMC

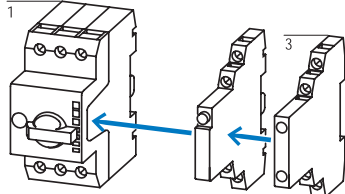
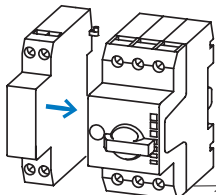
Part no. Article no.	Std. pack		Notes
AGM2-10-PKZ0 072898	2 off	<p>Can be fitted to the right side of motor-protective circuit-breakers:</p> <p>Can be combined with: Standard auxiliary contacts NHI11-PKZ0 NHI12-PKZ0 NHI21-PKZ0 NHI-E...</p>	
AGM2-01-PKZ0 072899	2 off	<p>Separate indication of: a) General trip indication (overload) b) Short-circuit trip</p> <p>Local short-circuit indication by red indicator, manually resettable.</p>	<p>Accessories</p> <p>1 Motor-protective circuit-breakers → 49</p> <p>3 Standard auxiliary contacts → 50</p>
VHI20-PKZ0 203595	2 off	<p>Can be fitted to front of motor-protective circuit-breaker, 45 mm width of the motor-protective circuit-breaker remains unchanged.</p> <p>For early energization of undervoltage release, e.g. in emergency switching off circuits to EN 60204.</p>	
A-PKZ0(230V50Hz) 073187	2 off	<p>Can be fitted to the left side of motor-protective circuit-breakers.</p>	
A-PKZ0(24V DC) 073200	2 off	<p>Cannot be combined with: undervoltage release U-PKZ0 DC: Intermittent operation 5 s</p>	
U-PKZ0(230V50Hz) 073135	2 off	<p>Can be fitted to the left side of motor-protective circuit-breakers.</p> <p>Cannot be combined with: A-PKZ0 shunt release When combined with circuit-breaker, can be used as emergency switching off device to IEC/EN 60204.</p>	<p>Accessories</p> <p>1 Motor-protective circuit-breakers → 49</p> <p>Further actuating voltages → 59</p>
CL-PKZ0 082881	1 off	<p>Max. rated operating voltage $U_e = 690$ V, rated uninterrupted current $I_u = 63$ A</p> <p>Can be used for individual and group protection.</p> <p>For group protection and in combination with PKZM4, order additional BK25/3 incoming terminal if required.</p> <p>Mounting next to or behind the motor-protective circuit-breaker.</p> <p>PKZM4: 16 – 63 A: 100 kA/400 V PKZM4: 16 – 63 A: 10 kA/690 V</p>	

1.2

Motor protection circuit breakers PKZMC

Insulated enclosure

1 Insulated enclosure

Enclosure

Accessories

Part no.

Degree of protection

Handle color

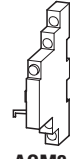
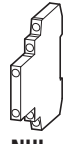

VHI..-PKZO

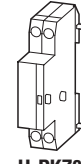

Surface mounting enclosure

For motor protective circuit breaker PKZMC

		CI-K2-PKZO	IP41	–	•	–	•	–	•	•
		CI-K2-PKZO	IP41	–	–	•	•	–	•	•
		CI-K2-PKZO-G	1P65	Black	•	–	•	–	•	•
		CI-K2-PKZO-G	1P65	Black	–	•	•	–	•	•
		CI-K2-PKZO-GR	1P65	Red-yellow	•	–	•	–	•	•
		CI-PKZO-M	IP40	–	•	–	•	–	•	•
		CI-PKZO-M	IP40	–	–	•	–	•	•	•
		CI-PKZO-GM	IP55	Black	•	–	•	–	•	•
		CI-PKZO-GM	IP55	Black	–	•	–	•	•	•
		CI-PKZO-GRM	IP55	Red-yellow	•	–	•	–	•	•

Surface mounting housings

For motor protective circuit breaker PKZMC + early-make auxiliary contact VHI-PKZO

		CI-K2-PKZO-GV	IP65	Black	•	–	–	•	•	•
		CI-K2-PKZO-GV	IP65	Black	–	•	–	•	•	•
		CI-K2-PKZO-GRV	IP65	Red-yellow	•	–	–	•	•	•
		CI-K2-PKZO-GVM	IP55	Black	•	–	–	•	–	•
		CI-K2-PKZO-GVM	IP55	Black	–	•	–	•	•	•
		CI-K2-PKZO-GRVM	IP55	Red-yellow	•	–	–	•	–	•

Flush mounting enclosure

For motor protective circuit breaker PKZMC









		E-PKZO	IP40	–	•	–	–	–	•	•	
		E-PKZO	IP40	–	–	–	–	•	•	•	
		E-PKZO-G	IP55	Black	•	–	•	–	–	•	•
		E-PKZO-G	IP55	Black	–	•	•	–	•	•	•
		E-PKZO1-GR	IP55	Red-yellow	•	–	•	–	–	•	•

Notes

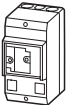
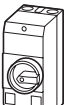
The combination possibilities of circuit-breakers in an enclosure with accessory modules are identified by a •
1) Always required

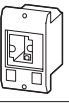
Insulated enclosure

1

		Degree of protection	For use with	Part no. Article no.	Std. pack	
Surface mounting enclosure						
For motor protective circuit breaker PKZMC						
	Cover with aperture dimensioned to accommodate front of breaker. IP40, when mounted turned through 90° to left/right	IP41 with vertical mounting	PKZMC-...+NHI or AGM+U or A (undervoltage or shunt release) +NHI-EL-PKZ0 (2 off)	CI-K2-PKZ0 219653	1 off	M25 metric cable entry knockout, top and bottom Cable push-through membrane top, bottom, in the back plate and as a control line entry.
	With black-grey rotary knob	IP65		CI-K2-PKZ0-G 219654	1 off	Insulated enclosure CI-K2 incl. N and PE terminal.
	With red-yellow rotary knob, for use as emergency switching off device to EN 60204	IP65		CI-K2-PKZ0-GR 219655	1 off	
	Cover with aperture dimensioned to accommodate front of breaker	IP40	PKZMC-... +NHI or U or A +L-PKZ0 (2 off)	CI-PKZ0-M 267083	1 off	Integrated terminal for PE(N) connection, two M25 cable entry knockouts at top and at bottom.
	With black-grey rotary knob	IP55	PKZMC-... +NHI-E	CI-PKZ0-GM 260089	1 off	
	With red-yellow rotary knob, for use as emergency switching off device to IEC/EN 60204	IP55	+NHI or U or A +L-PKZ0 (2 off)	CI-PKZ0-GRM 260104	1 off	
Surface mounting enclosure						
For motor protective circuit breakers PKZMC with early-make VHI-PKZ0 auxiliary contacts						
	With black-grey rotary knob	IP65	+NHI or AGM +U or A	CI-K2-PKZ0-GV 219657	1 off	M25 metric cable entry knockout, top and bottom Cable push-through membrane top, bottom, in the back plate and as a control line entry.
	With red-yellow rotary knob, for use as emergency switching off device to IEC/EN 60204	IP65	+L-PKZ0 (2 off)	CI-K2-PKZ0-GRV 219656	1 off	
	With black-grey rotary knob	IP55	PKZMC-...and VHI +U or A (undervoltage and shunt release)	CI-PKZ0-GVM 263526	1 off	Two M25 cable entry knockouts at top and at bottom.
	With red-yellow rotary knob, for use as emergency switching off device to IEC/EN 60204	IP55	+L-PKZ0 (2 off)	CI-PKZ0-GRVM 263525	1 off	
Flush mounting enclosure						
For motor protective circuit breaker PKZMC						
	Cover with aperture dimensioned to accommodate front of breaker	Front IP40	PKZMC-...+NHI or +U or A+L-PKZ0 (2 off)	E-PKZ0 072906	1 off	Integrated terminal for PE(N) connection, two PG16 cable entry knockouts at top and at bottom.
	With black-grey rotary knob	Front IP55	PKZMC-... +NHI or U or A	E-PKZ0-G 072907	1 off	
	With red-yellow rotary knob, for use as emergency switching off device to IEC/EN 60204	Front IP55	+NHI-E +L-PKZ0 (2 off)	E-PKZ0-GR 072908	1 off	
	For up to 3 padlocks with 3 – 6 mm hasp thickness, for use as main switch to IEC/EN60204		E-PKZ0-G(R)	SVB-PKZ0-E 035127	3 off	Lockable in Off position of PKZMC
Neutral terminal						
For connection of a 5th conductor						
			E-PKZ0(-G)(-GR)	N-PKZ0 082160	20 off	–

1

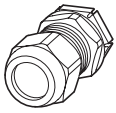

Metric cable glands to EN 50262

- With lock nut and built-in strain relief
- IP68 up to 5 bar

Cable entry	Drilling dimensions	External cable diameter	Part no. Article no.	Std. pack
	mm	mm		
M20	20.5	613	V-M20 206910	20 off
M25	25.5	917	V-M25 206911	20 off
M32	32.5	1321	V-M32 206912	10 off
M32	32.5	1825	V-M32G 226156	10 off



Metric diaphragm grommets

- IP66
- With integral push-through diaphragm

Cable entry	Drilling dimensions	External cable diameter	Part no. Article no.	Std. pack
	mm	mm		
M20	20.5	113	KT-M20 207602	100 off
M25	25.5	118	KT-M25 207603	100 off
M32	32.5	124	KT-M32 207604	100 off



Door coupling handles

- IP65

	Handle color	For use with	Part no. Article no.	Std. pack	
For use as main switch to IEC/EN 60204	Black	PKZMC	PKZ0-XH 106132	1 off	Pluggable PKZ0-XAH extension shaft, can be cut to any required length for installation depths of 100...240 mm. Follower included in delivery. With ON/OFF switch position and "+" (tripped), lockable. With 3 padlocks, 4 – 8 mm hasp.
For use as a main switch with emergency switching off function to IEC/EN 60204	Red/yellow	PKZMC	PKZ0-XRH 106133	1 off	
For use as a main switch to IEC/EN 60204 in MCC power distribution systems and with PKZMC installed rotated by 90°	Black	PKZMC	PKZ0-XH-MCC 106136	1 off	
For use as a main switch with emergency switching off function to IEC/EN 60204 in MCC power distribution systems and with PKZMC installed rotated by 90°	Red/yellow	PKZMC	PKZ0-XRH-MCC 106137	1 off	

Other accessories

1

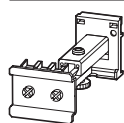

Telescopic adapters

With 45 mm top-hat rail to IEC/EN 60715 for compensation of the mounting depth of rear-mounted devices enclosures CI-K and cabinets.

For use with motor-protective circuit-breakers PKZMC	Part no. Article no.	Std. pack	
	M22-TA 226161	1 off	Stepless adjustment via scale from 75 – 115 mm



Lockable rotary handle

For locking motor-protective circuit-breakers PKZMC as a main switch in compliance with EN 60204.

Can be padlocked in the "0" position.

Hasp thickness: 3 – 6.35 mm

Holding facility

To prevent tampering with the overload release and the test function, it can be sealed using industry standard sealing wire

For use with motor-protective circuit-breakers PKZMC

	AK-PKZO 030851	5 off	–
	PL-PKZO 203599	5 off	–



Indicator lights with glow lamp

For use with

Color

Voltage

Part no.
Article no.

Std. pack

V

CI-K2-PKZO-... CI-K4-PKZ4 E-PKZO-... CI-PKZO1 E-PKZO1	White	110 – 230	L-PKZO(230V) 082151	10 off	–
E-PKZO-... CI-PKZO1 E-PKZO1	White	230 – 400	L-PKZO(400V) 082152	10 off	–
E-PKZO1	White	415 – 500	L-PKZO(500V) 082153	5 off	–
CI-K2-PKZO-... CI-K4-PKZ4 E-PKZO-... CI-PKZO1 E-PKZO1	Green	110 – 230	L-PKZO-GN(230V) 082154	10 off	–
CI-PKZO1 E-PKZO1	Green	230 – 400	L-PKZO-GN(400V) 082155	10 off	–
E-PKZO1	Green	415 – 500	L-PKZO-GN(500V) 082156	5 off	–
CI-K2-PKZO-... CI-K4-PKZ4 E-PKZO-... CI-PKZO1 E-PKZO1	Red	110 – 230	L-PKZO-RT(230V) 082157	10 off	–
CI-PKZO1 E-PKZO1	Red	230 – 400	L-PKZO-RT(400V) 082158	10 off	–
E-PKZO1	Red	415 – 500	L-PKZO-RT(500V) 082159	5 off	–

1.2

Motor protection circuit breakers PKZMC

Other accessories

Other accessories

	For use with	Part no. Article no.	Std. pack	Notes
wiring kit	PKZM0+DILM17..C PKZM0+DILM25..C PKZM0+DILM32..C	PKZM0-XM32DE 239349	5 off	<ul style="list-style-type: none"> Main supply wiring between PKZMC and contactor Use only in combination with busbar adapter

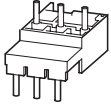

Other accessories

	circuit-breakers/ compact starters	length	Unit width	Part no. Article no.	Std. pack	Notes
	Number	mm	mm			

Three-phase commoning links, incoming unit via terminals 1, 3, and 5

Finger- and back-of-hand-proof, short-circuit proof, $U_e = 690V$, $I_u = 63A$
Can be extended through rotated installation

For PKZMC... without side-mounted auxiliary contacts or voltage releases

	2	90	45	B3.0/2-PKZO 063961	10 off	For parallel feeding of multiple motor-protective circuit-breakers on terminals 1, 3, and 5
	3	135	45	B3.0/3-PKZO 232289	10 off	
	4	180	45	B3.0/4-PKZO 063960	10 off	
	5	225	45	B3.0/5-PKZO 232290	10 off	

For motor-protective circuit-breakers with one auxiliary contact or trip-indicating auxiliary contact each fitted to right side

	2	99	45 + 9	B3.1/2-PKZO 044945	10 off	For parallel feeding of multiple motor-protective circuit-breakers on terminals 1, 3, and 5
	3	153	45 + 9	B3.1/3-PKZO 044946	10 off	
	4	207	45 + 9	B3.1/4-PKZO 044947	10 off	
	5	261	45 + 9	B3.1/5-PKZO 044948	10 off	

For PKZMC... with one auxiliary contact or trip-indicating auxiliary contact each fitted to right side, or one voltage release fitted on left side

	2	108	45 + 18	B3.2/2-PKZO 063963	10 off	For parallel feeding of multiple motor-protective circuit-breakers on terminals 1, 3, and 5
	4	234	45 + 18	B3.2/4-PKZO 063959	10 off	

Shroud for unused terminals

Protection against direct contact.

For covering unused terminals on three-phase commoning link B3...-PKZO

	–	–	–	H-B3-PKZO 032721	20 off	–
--	---	---	---	----------------------------	--------	---

Incoming terminals

	–	–	–	BK25/3-PKZO 032720	5 off	For three-phase commoning link, protected against accidental contact, $U_e = 690V$, $I_u = 63A$ For conductor cross-sections: 2.5 – 25 mm ² stranded 2.5 – 16 mm ² flexible with ferrule AWG 14 – 6, usable on terminals 1, 3, and 5
--	---	---	---	------------------------------	-------	---

Shunt release, undervoltage release

AC	A-PKZ0(...)	Std. pack	U-PKZ0(...)	Std. pack
	Article no. ¹⁾		Article no. ¹⁾	
Standard voltage				
24V 50Hz	073181	2 Off	073129	2 Off
110V 50Hz	073184	2 Off	073132	2 Off
220V 50Hz	073186	2 Off	073134	2 Off
230V 50Hz	073187	2 Off	073135	2 Off
380V 50Hz	073189	2 Off	073137	2 Off
Non-standard voltages not covered by above standard voltages²⁾				
... V 50Hz(24 – 500V)	982165	2 Off	982162	2 Off
... V 60Hz(24 – 600V)	982166	2 Off	982163	2 Off
DC				
Standard voltage				
24V DC	073200	2 Off	–	
110V DC	073203	2 Off	–	

Notes

- 1) The part number for ordering consists of the basic part number and the actuating voltage.
- 2) For non-standard voltages, specify the required actuating voltage within the indicated range (... - ... V). Minimum order quantity is 10 units.

1.2

Motor protection circuit breakers PKZMC

Tripping characteristic curves

1 Motor-protective circuit breaker PKZMC tripping characteristics

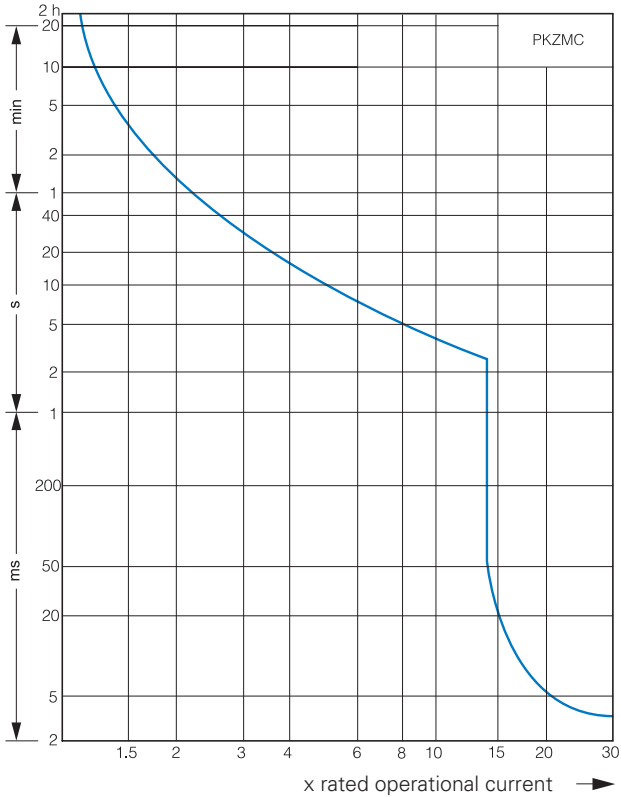

Let-through characteristics, motor-protective circuit-breaker

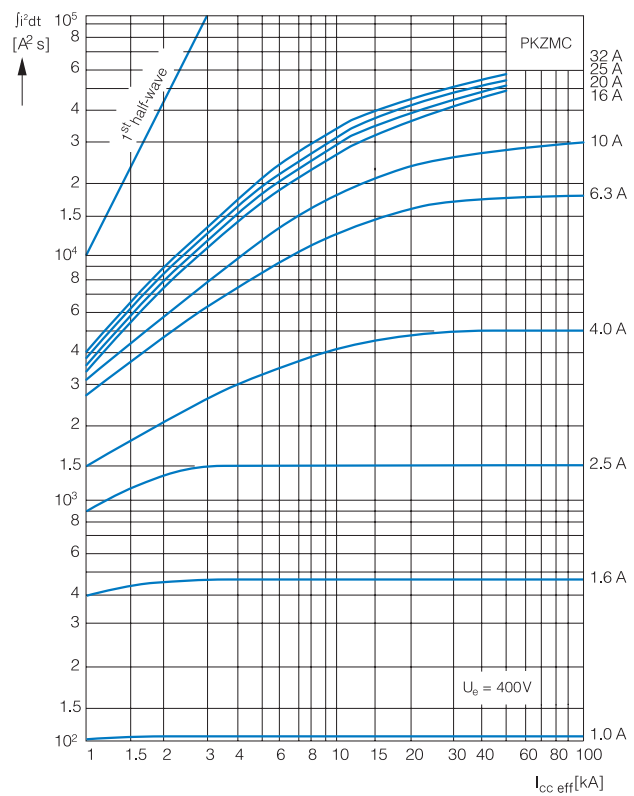
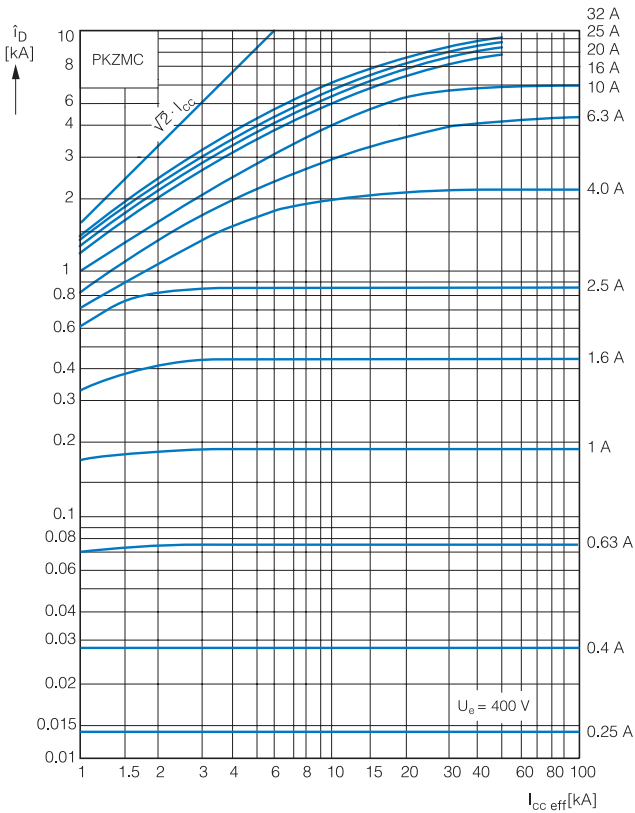

Circuit-breaker switching capacity from serial no. 04

Rated uninterrupted current I_u

Rated conditional short-circuit current I_q IEC/EN60947-4-1

Rated ultimate short-circuit breaking capacity I_{cu}
 Rated breaking capacity I_{cs} } IEC/EN 60947-2

I_u A	230V				400V				440V			
	I_q kA	I_{cu} kA	I_{cs} kA	A ¹⁾	I_q kA	I_{cu} kA	I_{cs} kA	A ¹⁾	I_q kA	I_{cu} kA	I_{cs} kA	A ¹⁾
PKZMC, With type "1" and "2" coordination												
0.16 - 1	65	65	65	N	65	65	65	N	65	65	65	N
1.6	65	65	65	N	65	65	65	N	65	65	65	N
2.5	65	65	65	N	65	65	65	N	65	65	65	N
4	65	65	65	N	65	65	65	N	65	65	65	N
6.3	65	65	65	N	16	16	8	50	6	6	3	50
10	16	16	8	50	16	16	8	50	6	6	3	50
12	16	16	8	50	16	16	8	50	6	6	3	50
16	16	16	8	50	16	16	8	50	6	6	3	50
20	12	12	6	50	12	12	6	50	6	6	3	50
25	12	12	6	50	12	12	6	50	6	6	3	50
32	12	12	6	50	12	12	6	50	6	6	3	50
PKZMC + CL-PKZO												
0.16 - 1				N				N				N
1.6				N				N				N
2.5				N				N				N
4				N				N				N
6.3				N				N				N
10				N				N				N
12				N				N				N
16				N				N				N
20				N				N				N
25				N				N				N
32				N				N				N
PKZMC + 2 CL-PKZO												
0.16 - 1				N				N				N
1.6				N				N				N
2.5				N				N				N
4				N				N				N
6.3				N				N				N
10				N				N				N
12				N				N				N
16				N				N				N
20				N				N				N
25				N				N				N
32				N				N				N

Notes

- No upstream protective device required, as it is the autoprotected range (100/150 kA)
- 1) Required back-up fuse if the short-circuit current exceeds the device's rated conditional short-circuit current ($I_{cc} > I_q$).
- N Not necessary

1 Technical data

PKZMC-...

General

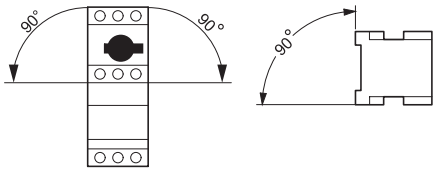
Standards				IEC/EN 60947, GB14048
Climatic proofing				Damp heat, constant, to IEC 60068-2-78 Damp heat, cyclic, to IEC 60068-2-30
Ambient temperature	Storage	°C	-25...80	
	Open	°C	-25...55	
	Encapsulated	°C	-25...40	
Built-in position				
Direction of incoming supply				Any
Degree of protection	Device	IP20		
	Terminals	IP00		
Contact protection to EN 50274				Finger- and back-of-hand proof
Shock resistance, half-sinusoidal shock, 10 ms to IEC 60068-2-27		g	25	
Installation altitude		m	2000	
Terminal capacity	Solid	mm ²	1 × (1 – 6) 2 × (1 – 6)	
		Flexible with ferrule to DIN 46228	mm ²	1 × (1 – 6) 2 × (1 – 6)
	Solid or stranded	AWG	18 – 10	
Terminal screw tightening torque				
Main conductors		Nm	1.7	
Auxiliary conductors		Nm	1	
Main contacts				
Rated impulse withstand voltage		U_{imp}	V AC	6000
Overvoltage category/pollution degree				III/3
Rated operational voltage		U_e	V AC	440
Rated uninterrupted current = rated operational current		$I_u = I_e$	A	32 or current setting of the overcurrent release
Rated frequency			Hz	40 – 60
Heat dissipation (3 pole at operating temperature)			W	6
Lifespan, mechanical		Operations	× 10 ⁶	0.05
Lifespan, electrical (AC-3 at 400 V)		Operations	× 10 ⁶	0.05
Maximum operating frequency		Operations/h	Ops/h	40
Short-circuit rating				
AC				→ Page 61
DC		kA	60 (Up to PKZMC-16) 40 (PKZMC-20 to PKZMC-32)	
Motor switching capacity	AC-3 (up to 690 V)	A		32
	DC-5 (up to 250 V)	A		25 (3 contacts in series)
Trip blocks				
Temperature compensation				
To IEC/EN 60947, VDE 0660		°C	-5...40	
Operating range		°C	-25...55	
Temperature compensation residual error for T > 40°C		%/K	≤ 0.25	
Setting range of overload releases		× I_u	0.6 – 1	
Fixed value of short-circuit releases		× I_u	14	
Short-circuit releases tolerance		%	± 20	
Phase-failure sensitivity				IEC/EN 60947-4-1, VDE 0660 Part102

Technical data

1

			NHI...PKZO	NHI-E...PKZO	VHI...PKZO	AGM
Auxiliary contacts						
Rated impulse withstand voltage	U_{imp}	V AC	6000	4000	4000	6000
Overvoltage category/pollution degree			III/3	III/3	III/3	III/3
Rated operational voltage	U_e	V AC	500	440	440	500
	U_e	V DC	250	250	250	250
Safe isolation according to EN 61140						
Between auxiliary contacts and main contacts		V AC	690	690	690	690
Rated operational current						
AC-15						
220-240V	I_e	A	3.5	1	1	3.5
380-415V	I_e	A	2	–	–	2
440-500V	I_e	A	1	–	–	1
DC-13 L/R ≤ 100 ms						
24 V	I_e	A	2	2	2	2
60 V	I_e	A	1.5	–	–	1.5
110 V	I_e	A	1	–	–	1
220 V	I_e	A	0.25	–	–	0.25
Durability						
Lifespan, mechanical	Operations	$\times 10^6$	0.1	0.1	0.1	0.01
Lifespan, electrical	Operations	$\times 10^6$	0.05	0.1	0.1	0.05
Control circuit reliability (at $U_e = 24$ V DC, $U_{min} = 17$ V, $I_{min} = 5.4$ mA)	Fault probability	λ	< one failure in 100 million operations			
Interlocked opposing contacts			Yes	–	–	–
Short-circuit rating without welding						
Fuseless			FAZ-B4/1-HI	–	–	FAZ-B4/1-HI
Fuse		A gG/gL	10	10	10	10
Terminal capacity						
Solid or flexible conductor with ferrule		mm ²	0.75 – 2.5	0.75 – 1.5	0.75 – 1.5	0.75 – 2.5
Solid or stranded		AWG	18 – 14	18 – 16	18 – 16	18 – 14

1 Technical data

U-PKZ...

undervoltage releases

conductor cross-sections	Solid or flexible conductor with ferrule	mm ²	1 × (0.75 – 2.5) 2 × (0.75 – 2.5)
	Solid or stranded	AWG	1 × (18 – 14) 2 × (18 – 14)

Main contacts

Rated operational voltage		U _e	V AC	42 – 480
Rated operational voltage		U _e	V DC	24 – 250
Pick-up voltage			× U _s	0.85 – 1.1
Drop-out voltage			× U _s	0.7 – 0.35
Power consumption	AC	Pick-up	VA	5
	AC	Holding	VA	3

Technical data

A-PKZ...

shunt releases

conductor cross-sections	Solid or flexible conductor with ferrule	mm ²	1 × (0.75 – 2.5) 2 × (0.75 – 2.5)
	Solid or stranded	AWG	1 × (18 – 14) 2 × (18 – 14)

Main contacts

Rated operational voltage		U _e	V AC	42 – 480
Rated operational voltage		U _e	V DC	24 – 250
Range of operational voltage	AC		× U _s	0.7 – 1.1
	DC (intermittent operation 5 s)		× U _s	0.7 – 1.1
Power consumption	AC	Pick-up	VA	5
		Holding	VA	3
	DC	Pick-up	W	3
		Holding	W	3

1- and 2-pole-connected PKZMC with AC and DC



Protection of PVC-insulated cables against thermal overload on short-circuits

The table specifies which minimum conductor cross-sections are protected by motor-protective circuit-breaker PKZMC up to their rated conditional short-circuit current I_q

Min. cross-section protected 380 – 415 V, 50 Hz, Cu mm ²					Device Part no.
4	2.5	1.5	1	0.75	
					PKZMC-0.16
					⋮
					PKZMC-6.3
					PKZMC-10
					PKZMC-16
					PKZMC-20
					PKZMC-25
					PKZMC-32
					PKZMC-16
					PKZMC-25
					PKZMC-32
					PKZMC-40
					PKZMC-50
					PKZMC-58
PKZMC-63					

Diagram of back-up protection by PKZ(M)

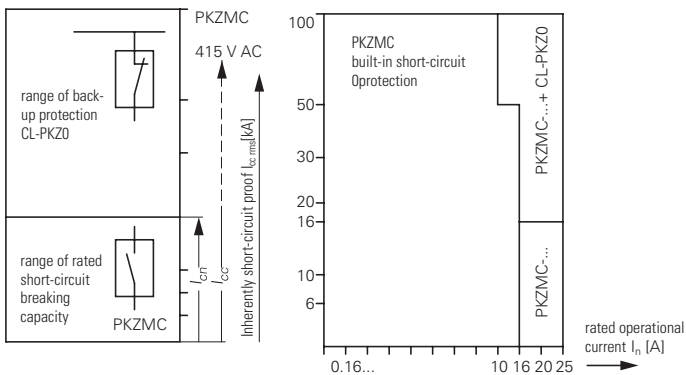

1.2

Motor protection circuit breakers PKZMC

Dimensions

1

Motor-protective circuit-breaker

PKZMC-...(+NHI-E...-PKZ0)

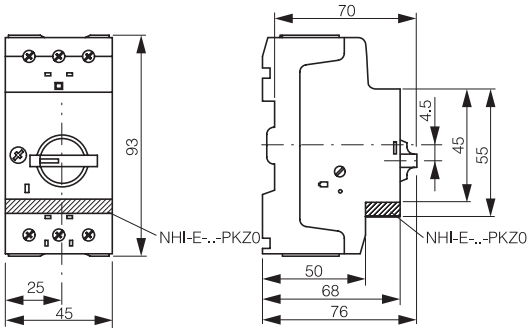

Motor-protective circuit-breakers with lockable rotary handles

PKZMC-...+AK-PKZ0

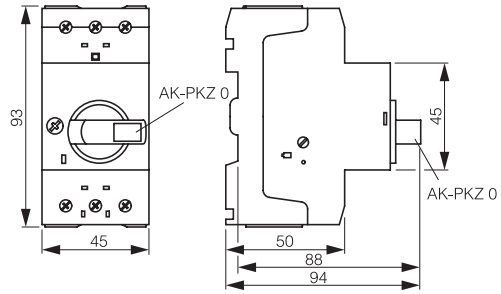

Current limiters

CL-PKZ...

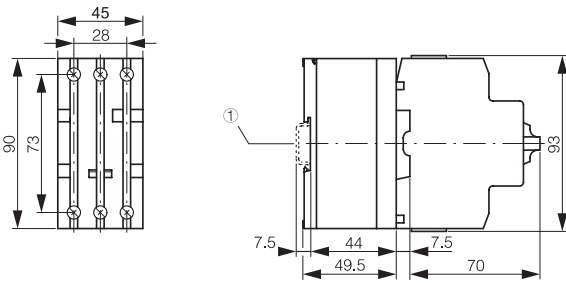

① IEC/EN 60715 Standard rail

Motor-protective circuit-breakers with early-make auxiliary contacts

PKZMC-...+VHI...-PKZ0

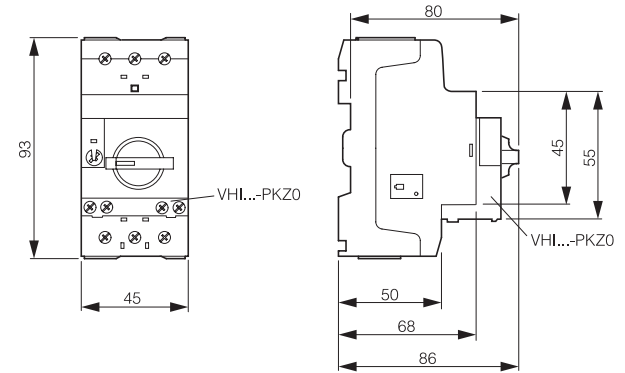

Standard auxiliary contacts

NHI...-PKZ0

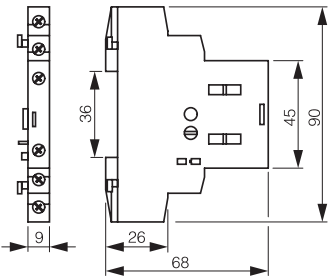

Trip indicators

AGM2...-PKZ0

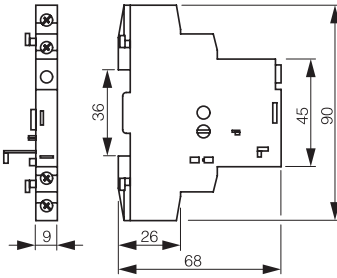

Undervoltage release

U/A-PKZ0

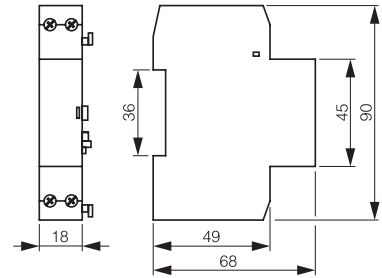

Insulated enclosures for surface mounting

CI-PKZ0

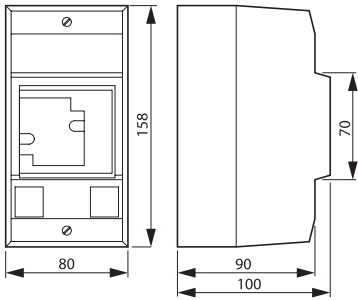

CI-PKZ0-G(R)(V)

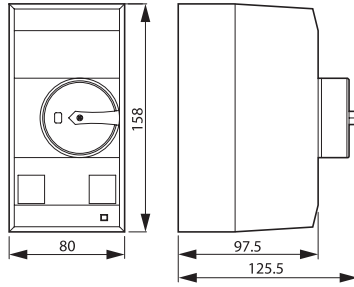

CI-PKZ0-G(R)(V)
+SVB-PKZ0-CI

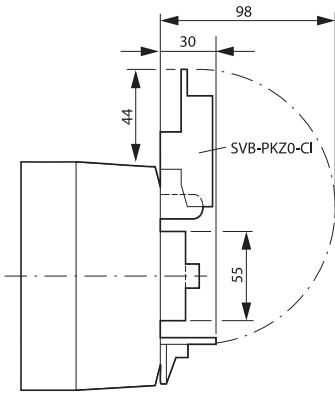

Drilling dimensions
CI-PKZ0...

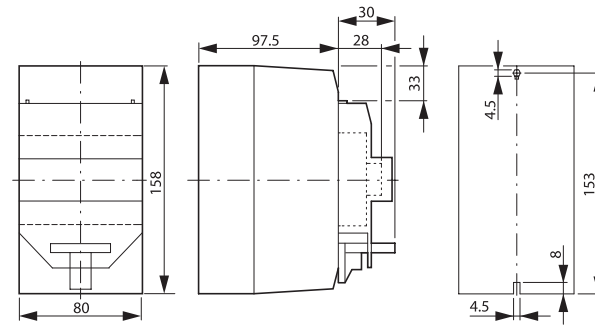

CI-K2-PKZ0

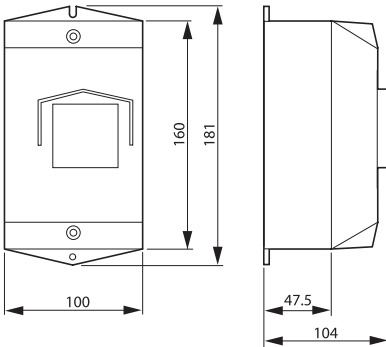

CI-K2-PKZ0G(R)(V)

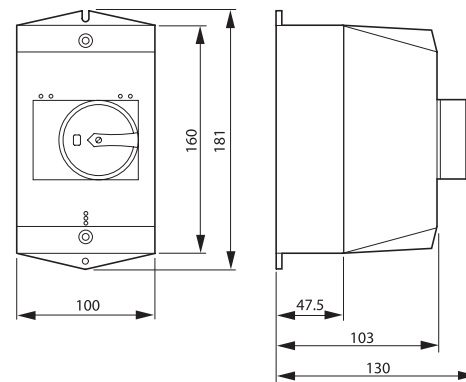

CI-K2-PKZ0-G(R)(V)
+SVB-PKZ0-CI

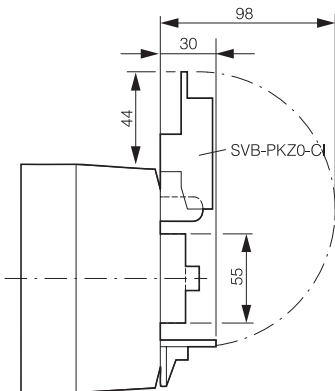

Drilling dimensions
CI-K2-PKZ0...

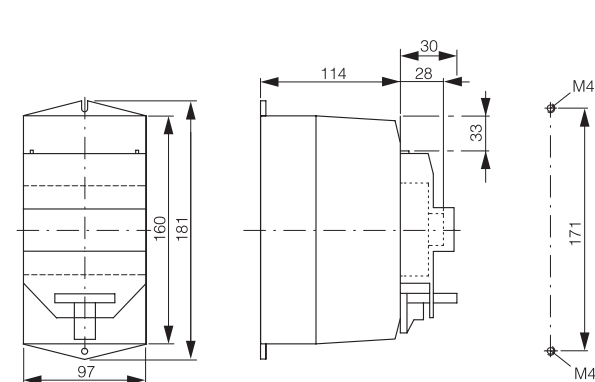

1.2

Motor protection circuit breakers PKZMC

Dimensions

1 Insulated enclosures for flush mounting

E-PKZ0
E-PKZ0-G(R)

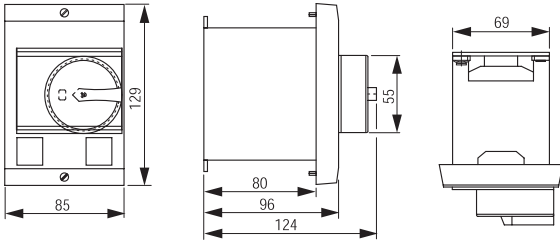

Mounting aperture
E-PKZ0...

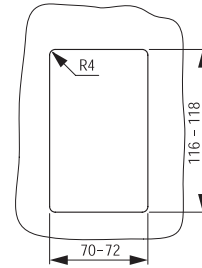

E-PKZ0-G(R)+SVB-PKZ0-E

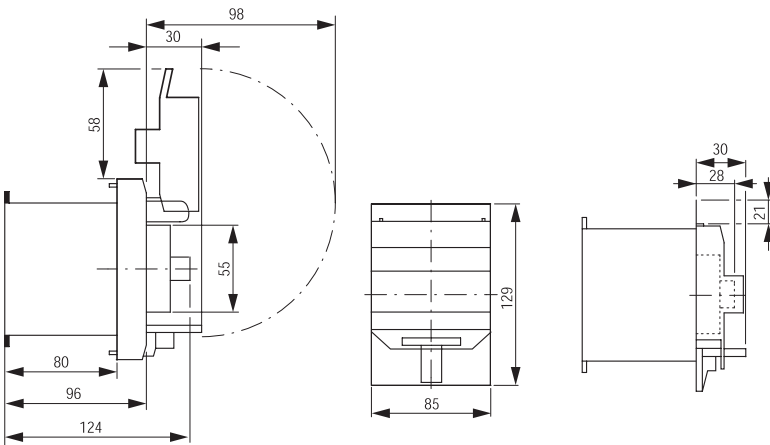

Door coupling handles

PKZ0-XH

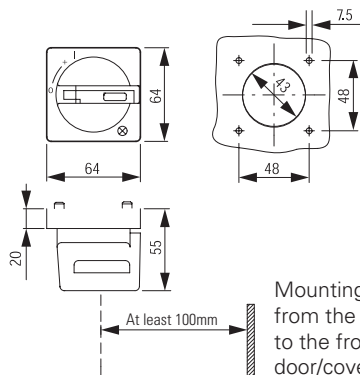

Mounting depth: 100 to 240 mm
from the top edge of the top-hat rail
to the front edge of the cabinet
door/cover